



LEVEL 2 OPTION BOOK 2018

BOTANY DOWNS Secondary College

CONTENTS

School Contacts	Page 3
Option Information	Page 4
Vocational Pathways	Page 5
BDSC Course Structure	Page 6
Departmental Subject flow charts	Page 7 - 14

LEVEL 2 COMPULSORY SUBJECTS

Every Year 12 student at Botany Downs Secondary College has English as a compulsory subject. For English there are 5 courses. This is chosen for the student by the Head of English according to the student's grades from Year 11.

English (2ENG)	Page 15
English - Alternative (2ENA)	Page 16
English - Extended (2ENE)	Page 17
English as an Additional Language (2ENP)	Page 18
English as an Additional Language (2ENS)	Page 19

LEVEL 2 OPTIONAL SUBJECTS

Every Year 12 student at Botany Downs Secondary College can choose 5 options. Information for these courses can be found on the following pages listed.
Note: some courses can not be taken together. Please check page 4 for details.

Accounting (2ACC)	Page 20
Art History (2ARH)	Page 21
Automotive Engineering (2ATM)	Page 22
Biology (2BIO)	Page 23
Biology - Alternative (2BIA)	Page 24
Building Construction (2BCN)	Page 25
Business Studies (2BUS)	Page 26
Calculus - Accelerated (2MAX)	Page 27
Career Pathways (2CAP)	Page 28
Chemistry (2CHE)	Page 29
Chemistry - Alternative (2CHA)	Page 30

Chinese (2CHI)	Page 31
Classical Studies (2CLS)	Page 32
Dance (2DAN)	Page 33
Design and Visual Communication (2DVC)	Page 34
Digital Technologies with Info Systems (2DIT)	Page 35
Digital Technologies with Programming (2DIP)	Page 36
Drama (2DRA)	Page 37
Early Childhood Education (2ECE)	Page 38
Economics (2ECO)	Page 39
Electronics (2ELE)	Page 40
Financial Studies (2FIN)	Page 41
Food & Hospitality (2FAH)	Page 42
Food Technology (2TEF)	Page 43
French (2FRE)	Page 44
Geography (2GEO)	Page 45
Health Education (2HED)	Page 46
History (2HIS)	Page 47
Japanese (2JAP)	Page 48
Mathematics & Statistics (2MAT)	Page 49
Mathematics & Statistics - Alternative (2MAA)	Page 50
Mathematics & Statistics - Extended (2MAE)	Page 51
Media Studies (2MED)	Page 52
Microsoft Office Specialist (2MOS)	Page 53
Multi-Material Technology (2TEM)	Page 54
Music (2MUS)	Page 55
Outdoor Education (2OED)	Page 56
Outdoor Education - Alternative (2ODA)	Page 57
Physical Education (2PED)	Page 58
Physics (2PHY)	Page 59
Spanish (2SPH)	Page 60
Sports Leadership (2SPL)	Page 61
Te Reo Maori (2MAO)	Page 62
Textiles Technology (2TET)	Page 63
Travel and Tourism (2TSM)	Page 64
Visual Art - Design (2DES)	Page 65
Visual Art - Painting (2ART)	Page 66
Visual Art - Photography (2PHO)	Page 67

SCHOOL CONTACTS



Botany Downs Secondary College
575 Chapel Road, Howick
Auckland 1706

Phone (09) 273-2310

Fax (09) 273-8551

Email admin@bdsc.school.nz

Web Site www.bdsc.school.nz

SENIOR LEADERSHIP TEAM

Principal	<i>K. Brinsden</i>
Deputy Principal	<i>K. Holmes</i>
Deputy Principal	<i>M. Hart</i>
Deputy Principal	<i>C. Williams</i>
Deputy Principal	<i>M. Andrew</i>
Director of Academic Studies	<i>C. Van Kralingen</i>

HEADS OF LEARNING AREAS

English	<i>K. Pinnell</i>
Health and Physical Education	<i>J. Saville</i>
Languages	<i>M. Lodge</i>
Mathematics and Statistics	<i>I. Bennet</i>
Science	<i>L. Kumar</i>
Social Sciences	<i>M. Andrew (Acting)</i>
Technology	<i>D. Achary</i>
Visual and Performing Arts	<i>J. Hood, L. Treneman, T. Clapperton, A. Rakanui</i>

WHĀNAU HOUSE LEADERS

Blake Whānau	<i>A. Taylor</i>
Britten Whānau	<i>D. McGregor</i>
Discovery Whānau	<i>N. Folks</i>
Endeavour Whānau	<i>K. Adams</i>
Koru Whānau	<i>J. Clark</i>
Spirit Whānau	<i>S. Jackson</i>

STUDENT SERVICES

Guidance Counsellor	<i>I. Thomson (Head of Guidance), L. Rowe</i>
Careers Advisor	<i>M. Drum</i>
Trade Academies/Vocational Pathways	<i>K. Stewart</i>
Gateway	<i>N. Shand-Marcusson</i>

OPTION INFORMATION

The following booklet contains information of the Level 2 programme at BDSC.

- All following subjects will run depending on the number of applicants and availability of staff and facilities (in practical subjects).
- Entry to some courses will be limited.
- Entry to all courses will be at the discretion of the appropriate Head of Learning Area.
- The final selection of standards per subject (worth approx 18-21 credits) will be made by the HOLA from the standards presented in this option booklet.
- The column labelled “CODES” contains:
 - L or N which identifies standards that can contribute to the 10 Numeracy credits and 10 Literacy credits required to achieve NCEA Level 1.
 - R or W which identifies standards that can contribute to the Reading and Writing credits for the University Entrance Literacy requirements.
- NOTE:
 - Can not choose both 2FAH and 2TEF
 - Can not choose both 2ATM and 2BCN
 - Can not choose both 2OED and 2ODA
 - Can only do 1 max of 2TEM, 2TET and 2TEF
 - Can only do 2 max of 2PHO, 2DES and 2ART (and be wary of a 3rd high internal subject)
 - Can only do 2 max of 2PED, 2SPL, 2OED/2ODA
 - Can only do 2 max of 2DIT, 2DIP and 2TEM/2TET/2TEF
 - Can not choose 2SPL with either 2OED or 2PED
 - Can not choose 2MOS with either 2DIP or 2DIT

VOCATIONAL PATHWAYS

Vocational Pathways is a Ministry of Education tool that has been developed to help students to plan their journey from secondary learning to the work force. Additional information is available in the Level 1 - 3 information book.



The pathways will help students see how learning is relevant to a wide range of jobs and study options, in six broad sectors of industry:

Construction and Infrastructure Sector,
Services Industries Sector,

Manufacturing and Technology Sector,
Social and Community Services Sector and

Primary Industries Sector,
Creative Industries Sector

VOCATIONAL PATHWAYS AWARDS

In Level 2, students can be awarded a VOCATIONAL PATHWAYS AWARD in a particular sector, i.e. they can be awarded a VOCATIONAL PATHWAYS AWARD IN CREATIVE INDUSTRIES. Students can gain awards from multiple sectors if they meet the below criteria in each of the multiple sectors.

HOW TO GAIN AN AWARD:

Once a student has gained NCEA Level 2, to get a Vocational Pathways Award, 60 credits must come from standards which are linked to a particular sector *ie the Creative Industries Sector*. At least 20 of those credits must come from SECTOR RELATED standards and the remainder (40 credits) can be from RECOMMENDED standards.

On each option page there is a coloured ticked section indicating which standards relate to which industry sector.

- ✓✓ refers to credits which count towards *SECTOR RELATED STANDARDS* and
- ✓ refers to credits which count towards *RECOMMENDED STANDARDS*.

For example, to be awarded with a VOCATIONAL PATHWAYS AWARD IN CREATIVE INDUSTRIES, a student needs 60 credits from standards which are linked to Creative Industries. At least 20 of these must come from standards which are SECTOR RELATED (double ticked ✓✓ in the yellow Creative Industries column), and the remainder 40 credits must come from standards which are RECOMMENDED (single ticked ✓ in the yellow Creative Industries column). It doesn't matter which subjects these credits came from, as long as they are from the same Sector of Industry.

For example Level 2 Food Technology:

“AS91352 Implement advanced procedures to process a specified product (4 credits)”, has links to 2 sectors; Manufacturing & Technology and Primary Industries. The Manufacturing & Technology has a double tick so its 4 credits will count towards the SECTOR RELATED count for the Manufacturing & Technology Award, but the Primary Industries has a single tick so its 4 credits will count towards the RECOMMENDED count for the Primary Industries Award. This gives the student an idea of the real-world application of the knowledge learnt during this standard as well as contributing to the various Sector Awards credit counts.

STANDARDS						VOCATIONAL PATHWAYS					
Number	Subject Ref	Title	Int/Ext	Credits	CODES	Construction & Infrastructure	Manufacturing & Technology	Primary Industries	Services Industries	Social & Community Services	Creative Industries
<i>NCEA Internal Achievement Standards/Unit Standards</i>											
AS91354	Technology 2.1	Undertake brief development to address an issue	Internal	4		✓	✓	✓			✓✓
AS91356	Technology 2.3	Develop a conceptual design for an outcome	Internal	6		✓	✓✓	✓			✓
AS91352	Technology 2.61	Implement advanced procedures to process a specified product	Internal	4	L		✓✓	✓			
<i>NCEA External Achievement Standards</i>											
AS91358	Technology 2.5	Demonstrate understanding of how technological modelling supports risk management	External	4		✓	✓				
				<i>Possible Credits Available</i>							
				18 Credits							
						Total recommended ✓ credits					
						14	8	14			6
						Total sector related ✓✓ credits					
							10				4

BDSC COURSE STRUCTURE 2018

<i>Learning Areas</i>	<i>Year 9</i>	<i>Year 10</i>	<i>Level 1</i>	<i>Level 2</i>	<i>Level 3</i>
English	English (9ENG) English Literacy Support (9ENA)	English (10ENG) English Literacy Support (10ENA) Media Studies (10MED)	English (1ENG) English - Alternative (1ENA) English - Extension (1ENE) Media Studies (1MED)	English (2ENG) English - Alternative (2ENA) English - Extension (2ENE) Media Studies (2MED)	English (3ENG) English Booster Course (32ENB-L2/3 AS) English—Extension (3ENE) Media Studies (3MED)
	English as an Additional Language (9ENS)	English as an Additional Language (10ENS) English as an Additional Language (10ENP)	English as an Additional Language (1ENS) English as an Additional Language (1ENP)	English as an Additional Language (2ENS) English as an Additional Language (2ENP)	English as an Additional Language (3ENS)
Health & Physical Education	Health & PE (9HPE)	Health & PE (10HPE) Outdoor Leadership (10ODL) Physical Education (10PED)	Health & PE (1HPE) Early Childhood Education (1ECE) Health Education (1HED) Outdoor Education (1OED) Physical Education (1PED)	Early Childhood Education (2ECE) Health Education (2HED) Outdoor Education (2OED) Outdoor Education Alternative (2ODA) Physical Education (2PED) Sports Leadership (2SPL)	Early Childhood Education (3ECE) Health Education (3HED) Outdoor Education (3OED) Physical Education (3PED) Sports Leadership (3SPL)
Languages	French (9FRE) Japanese (9JAP) Maori (9MAO)	French (10FRE) Japanese (10JAP) Maori (10MAO) Spanish (10SPH)	French (1FRE) Japanese (1JAP) Maori (1MAO)* Spanish (1SPH)	Chinese (2CHI) French (2FRE) Japanese (2JAP) Maori (2MAO)* Spanish (2SPH)	Chinese (3CHI) French (3FRE) Japanese (3JAP) Maori (3MAO)* Spanish (3SPH)
Mathematics	Mathematics and Statistics (9MAT)	Mathematics and Stats (10MAT) Mathematics and Stats - Alt (10MAA) Mathematics and Stats - Ext (10MAX1) L1 standards for Y10 accelerated students	Mathematics and Statistics - Alt (1MAA) Mathematics and Statistics (1MAT) Maths. and Stats. - Numeracy (1MNU) Mathematics and Statistics - Ext (2MAX) for L1 accelerated students	Mathematics and Statistics – Alt (2MAA) Mathematics and Statistics (2MAT) Mathematics and Statistics – Ext (2MAE) Mathematics and Calculus - Ext (3MAX) for L2 accelerated students	Calculus (3MAC) Calculus - Alt (3MCA) Statistics and Probability (3SAP) Statistics and Probability - Alt (3SPA) Mathematics (3MAT)
Science	Science (9SCI)	Science (10SCI) Science—Ext (SCX1) L1 standards for Y10 accelerated students Electronics (10ELE)	Science - Core (1SCI) Science - Alternative (1SCA) Science - Supplementary Science (1SCS) Electronics (1ELE)	Biology (2BIA, 2BIO) Chemistry (2CHA, 2CHE) Electronics (2ELE) Physics (2PHY)	Biology (3BIA, 3BIO) Chemistry (3CHE) Electronics (3ELE) Physics (3PHY)
Social Sciences	Social Studies (9SOS)	Social Studies (10SOS) Ancient Civilisations (10ANC) Business Pathways (10BUP) Investigative Geography (10IGO)	Accounting (1ACC) Business Studies (1BUS) Economics (1ECO) Geography (1GEO) History (1HIS)	Accounting (2ACC) Business Studies (2BUS) Classical Studies (2CLS) Economics (2ECO) Financial Studies (2FIN) Geography (2GEO) History (2HIS) Travel and Tourism (2TSM)	Accounting (3ACC) Business Studies (3BUS) Classical Studies (3CLS) Economics (3ECO) Financial Studies (3FIN) Geography (3GEO) History (3HIS) Travel and Tourism (3TSM)
Technology	Design and Visual Com. (9DVC) Food Technology (9TEF) Multi Materials Technology (9TEM) Textiles Technology (9TET)	Design and Visual Com. (10DVC) Digital Technology (10DIT) Food Technology (10TEF) Multi Materials Technology (10TEM) Textiles Technology (10TET)	Digital Technology (1DIT) Design and Visual Com. (1DVC) Food and Hospitality (1FAH) Food Technology (1TEF) Multi Materials Technology (1TEM) Textiles Technology (1TET)	Automotive Engineering (2ATM) Building Construction (2BCN) Digital Technology - Programming (2DIP) Digital Technology (2DIT) Digital Technology (2DIT) Design and Visual Com. (2DVC) Food and Hospitality (2FAH) Food Technology (2TEF) Microsoft Office Specialist (2MOS) Multi Materials Technology (2TEM) Textiles Technology (2TET)	Digital Technology - Programming (3DIP) Digital Technology (3DIT) Design and Visual Com. (3DVC) Food and Hospitality (3FAH) Food Technology (3TEF) Microsoft Office Specialist (3MOS) Multi Materials Technology (3TEM) Textiles Technology (3TET)
The Arts	Dance (9DAN) Drama (9DRA) Music (9MUS) Visual Art (9ART)	Dance (10DAN) Digital Art (10DRT) Drama (10DRA) Music (10MUS) Visual Art (10ART)	Dance (1DAN) Digital Art (1DRT) Drama (1DRA) Music (1MUS) Visual Art (1ART)	Dance (2DAN) Drama (2DRA) Music (2MUS) Visual Art (2ART) Art History (2ARH) Design (2DES) Photography (2PHO)	Dance (3DAN) Drama (3DRA) Making Music (Practical) (3MUP) Music Studies (3MUS) Visual Art (3ART) Art History (3ARH) Design (3DES) Photography (3PHO)
Vocational & General Courses			Work and Community Studies (1WCS)	Careers Pathways (2CAP)	Careers Pathways (3CAP)

ENGLISH FLOWCHART 2018

Key:

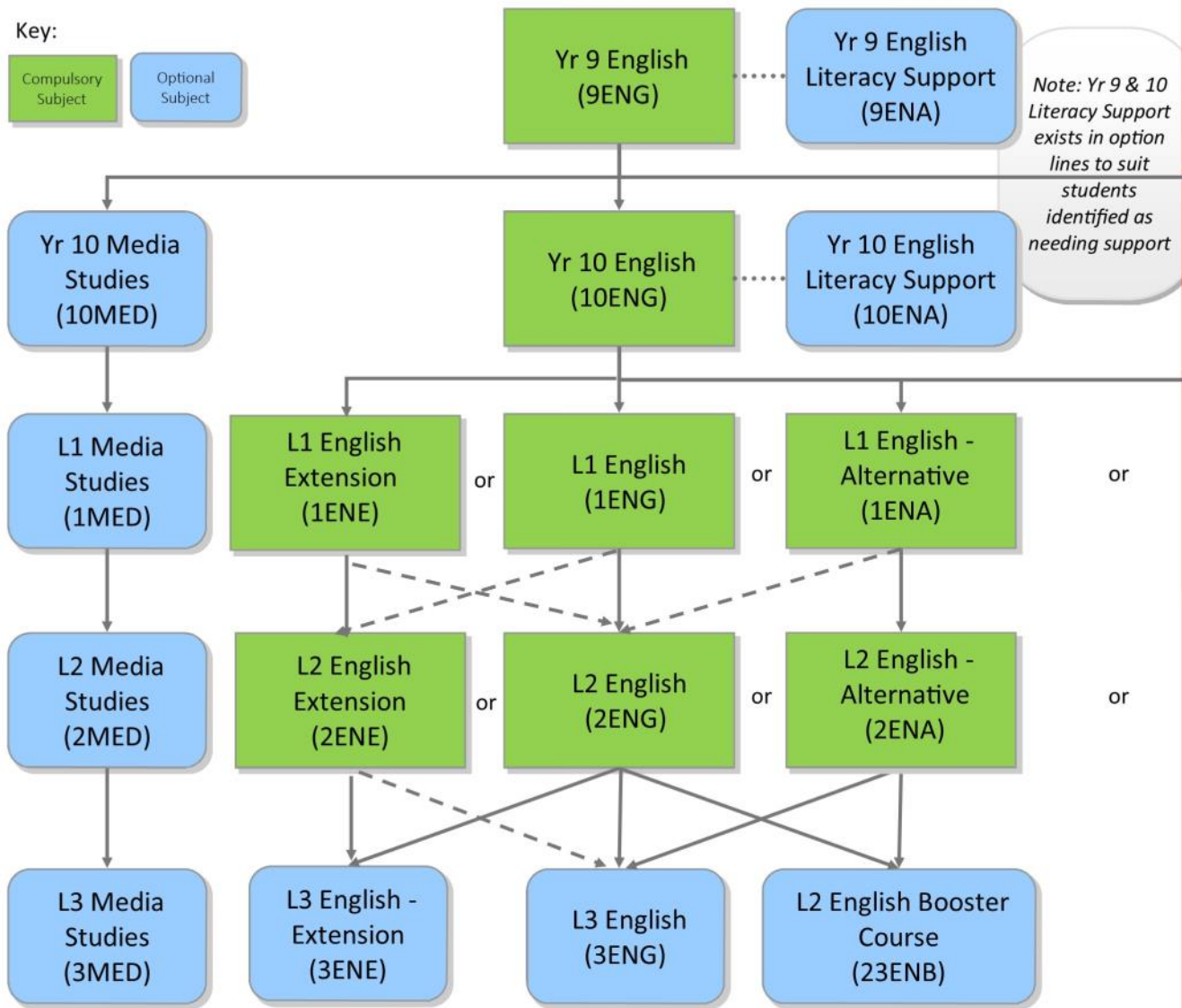

ENGLISH AS ADDITIONAL LANGUAGE (EAL) FLOWCHART 2018

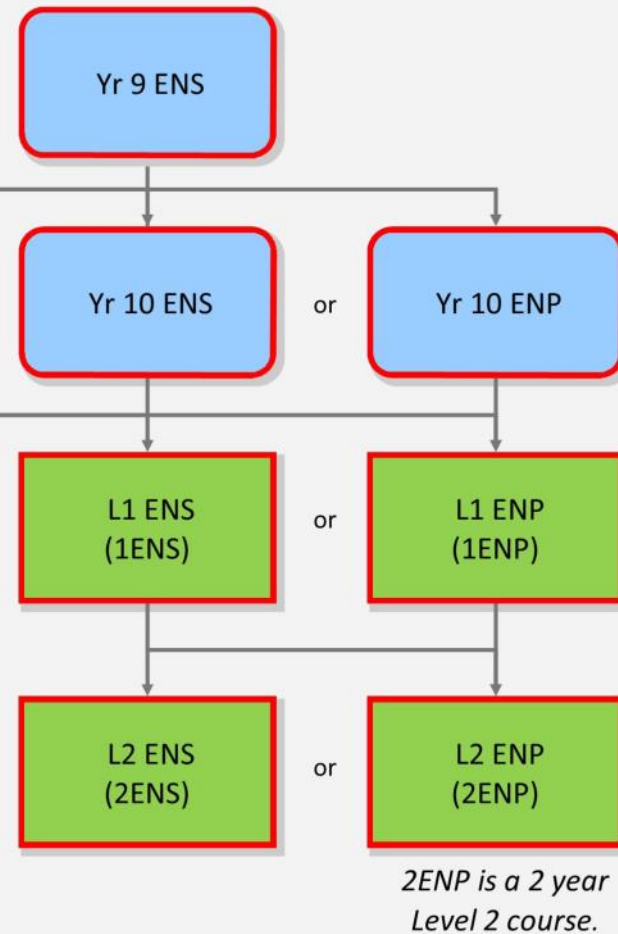

Note: Yr 9 & 10 Literacy Support exists in option lines to suit students identified as needing support

ENGLISH AS AN ADDITIONAL LANGUAGE

At Year 9 and 10 identified students may be removed from a Year 9 class or a Year 10 option line to attend 9ENS or 10ENS/10ENP class to support their language development.
 At Year 11/12/13 identified students may be placed in ENS or ENP instead of ENG, dependant on the Head of EAL recommendation. Students may be swapped between ENS and ENP depending on the level of English.

HEALTH & PHYSICAL EDUCATION FLOWCHART 2018

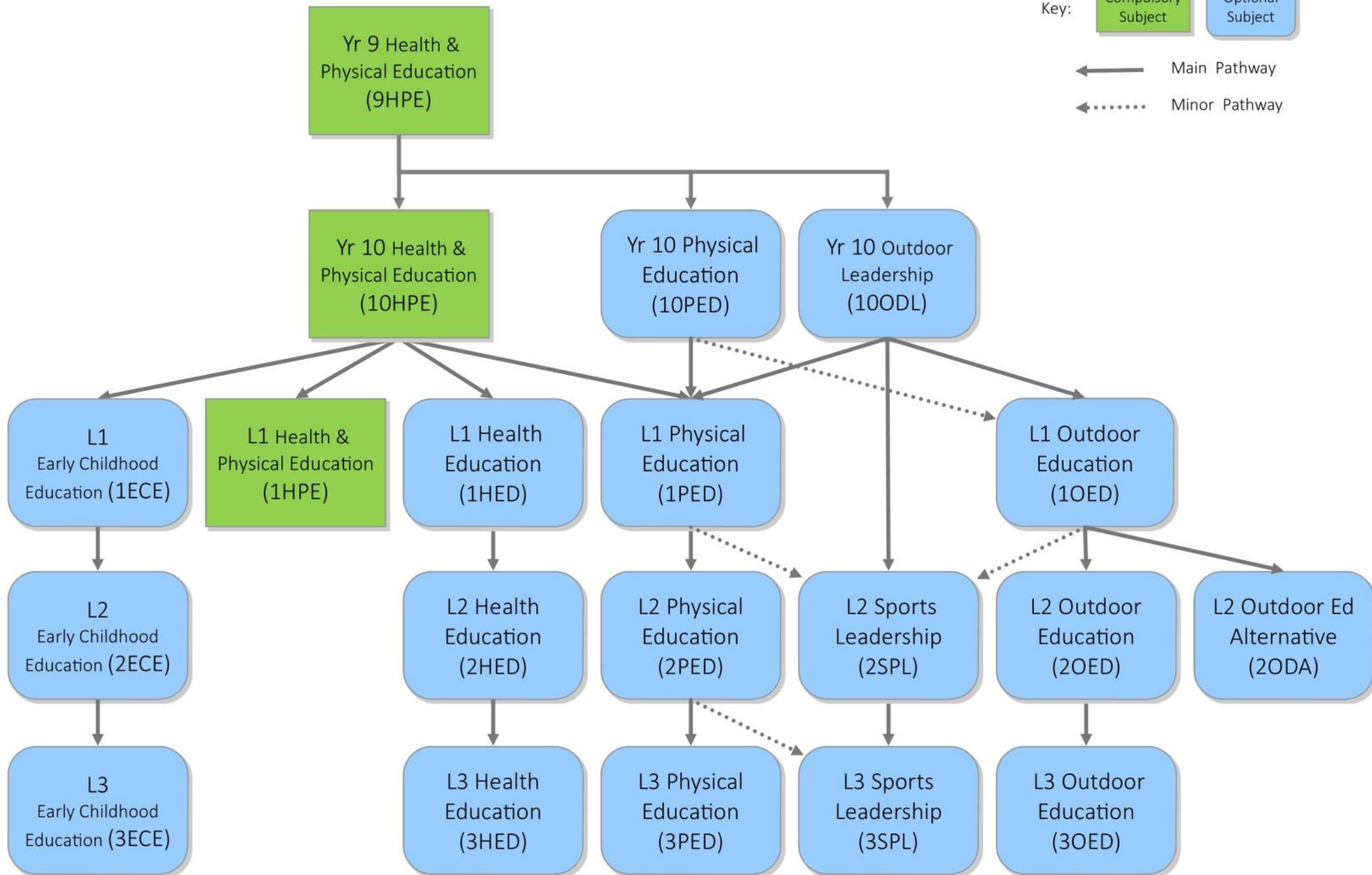
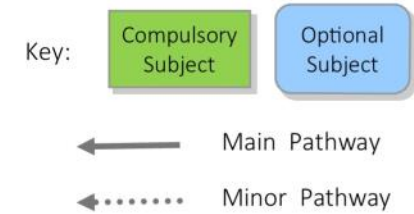

LANGUAGES FLOWCHART 2018

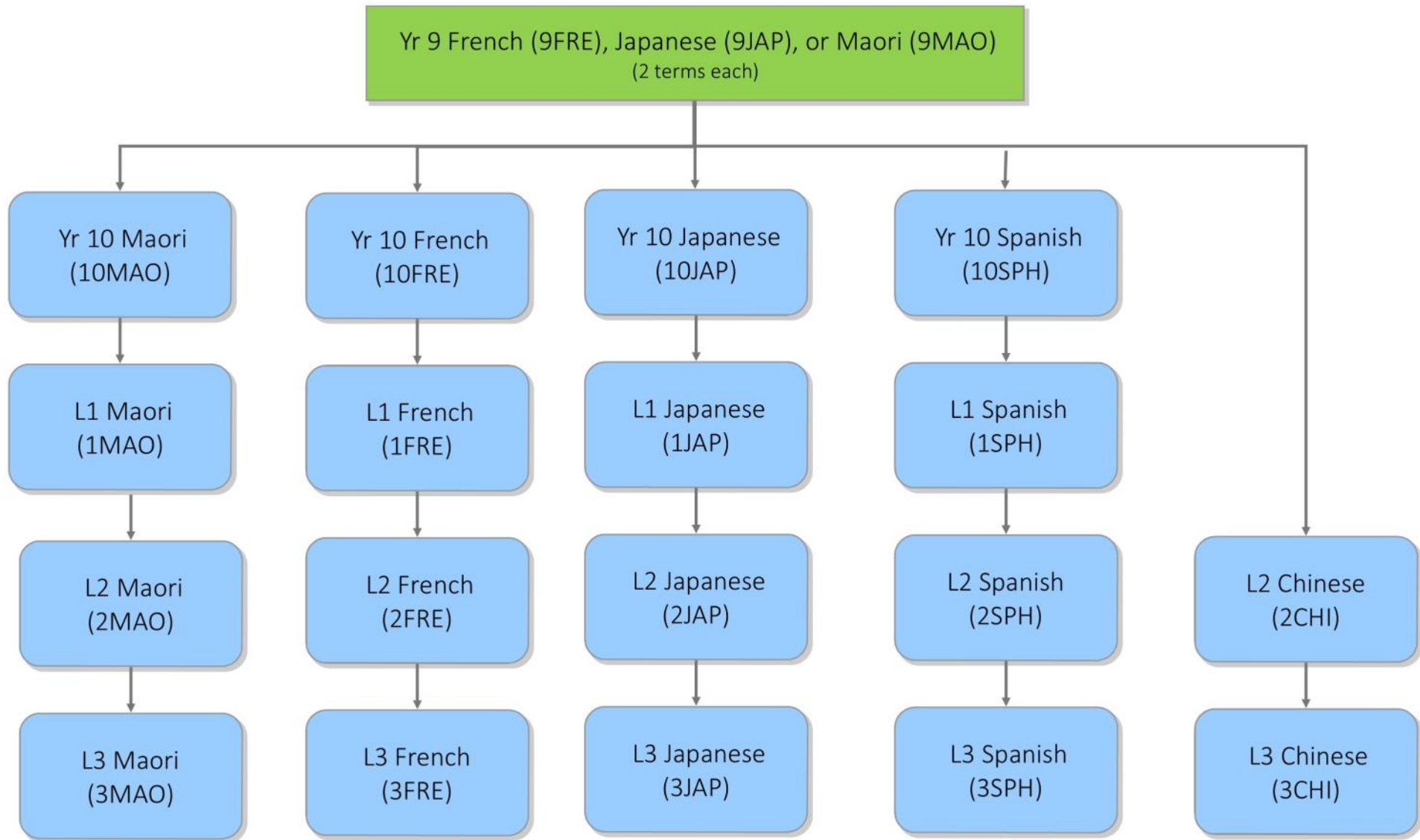

MATHEMATICS & STATISTICS FLOWCHART 2018

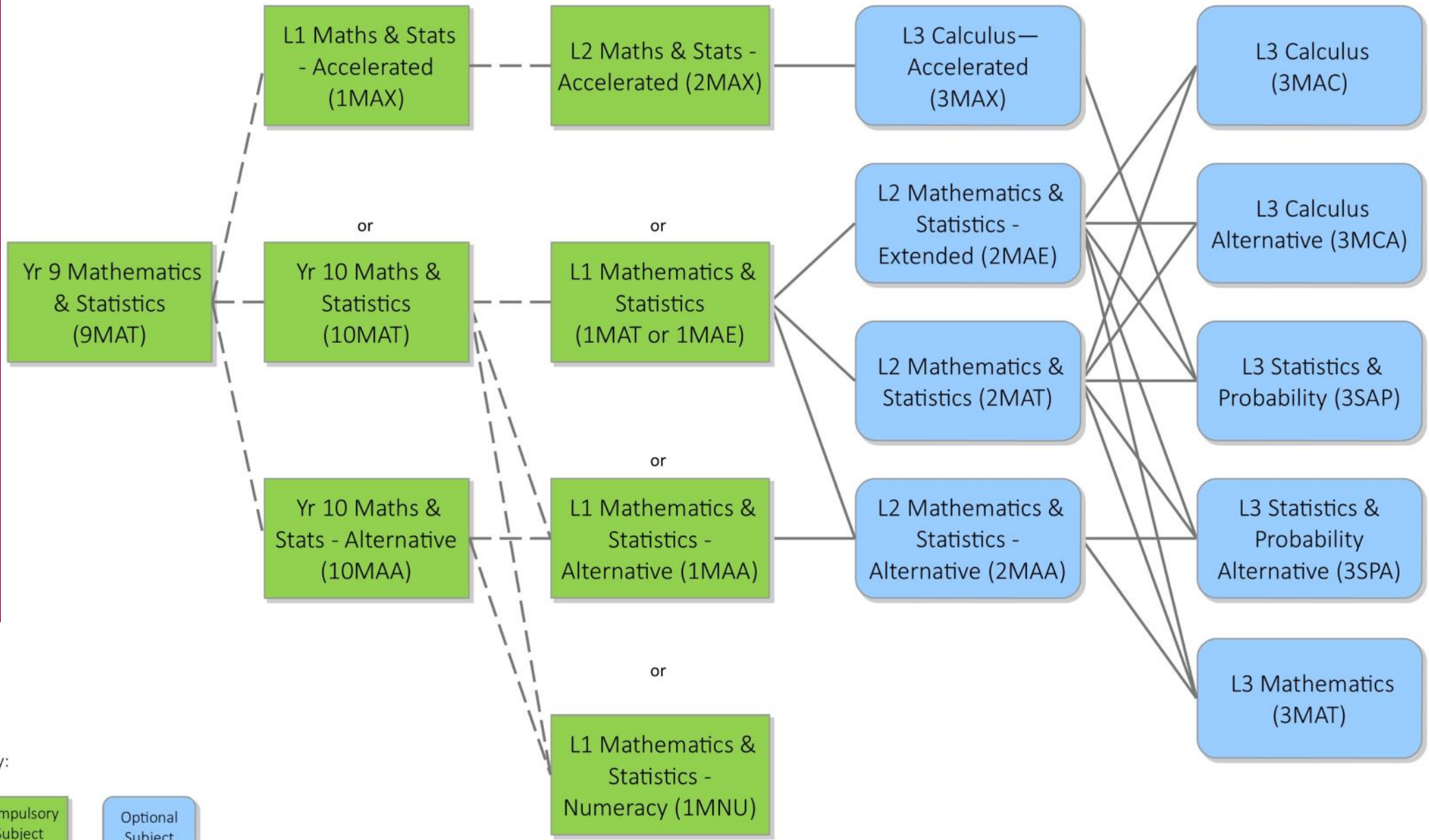

Key:



Key: Dashed lines refer to courses which are selected for the students by Mathematics staff

SCIENCE FLOWCHART 2018

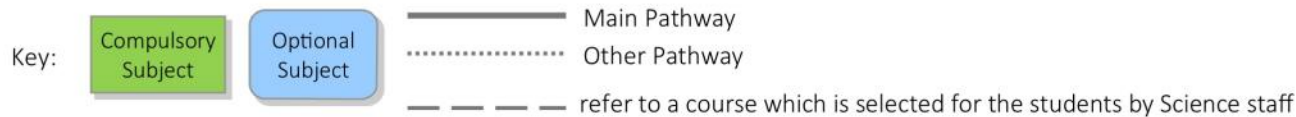
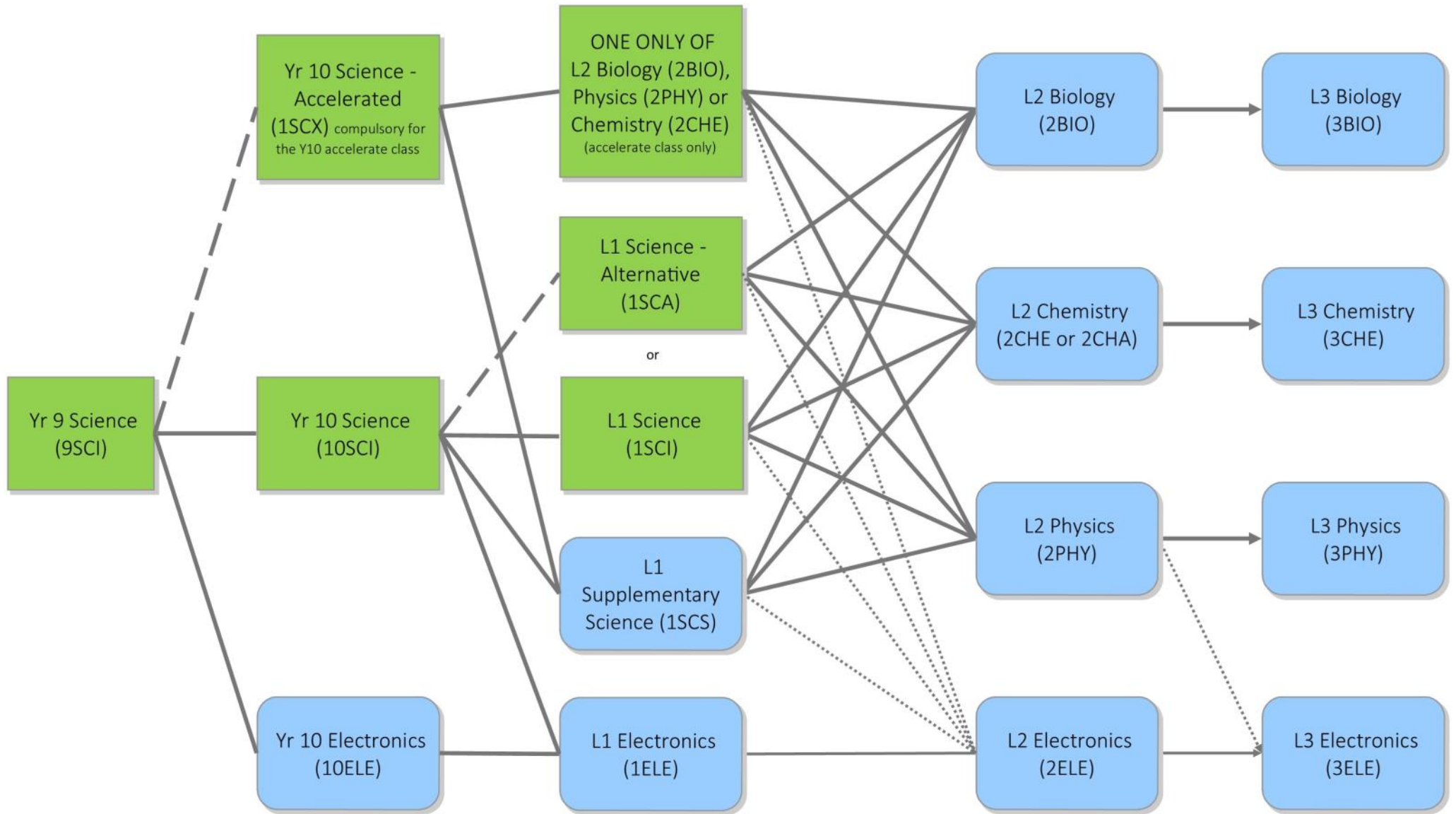

SOCIAL SCIENCES FLOWCHART 2018

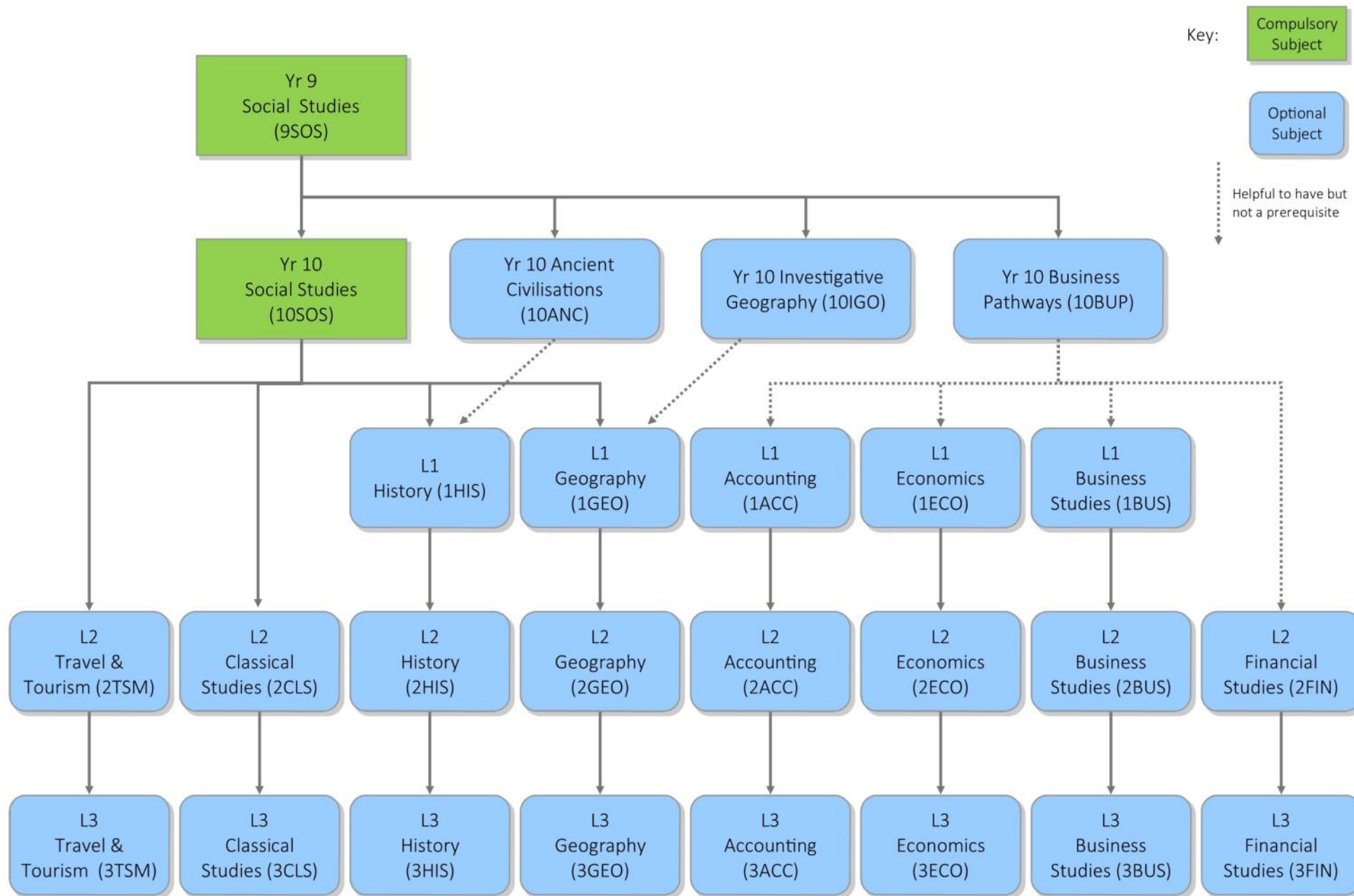

TECHNOLOGY FLOWCHART 2018

Yr 9 Food (9TEF), Textiles (9TET), Design & Visual Communication (9DVC), Multi Materials (9TEM) (1 term each)

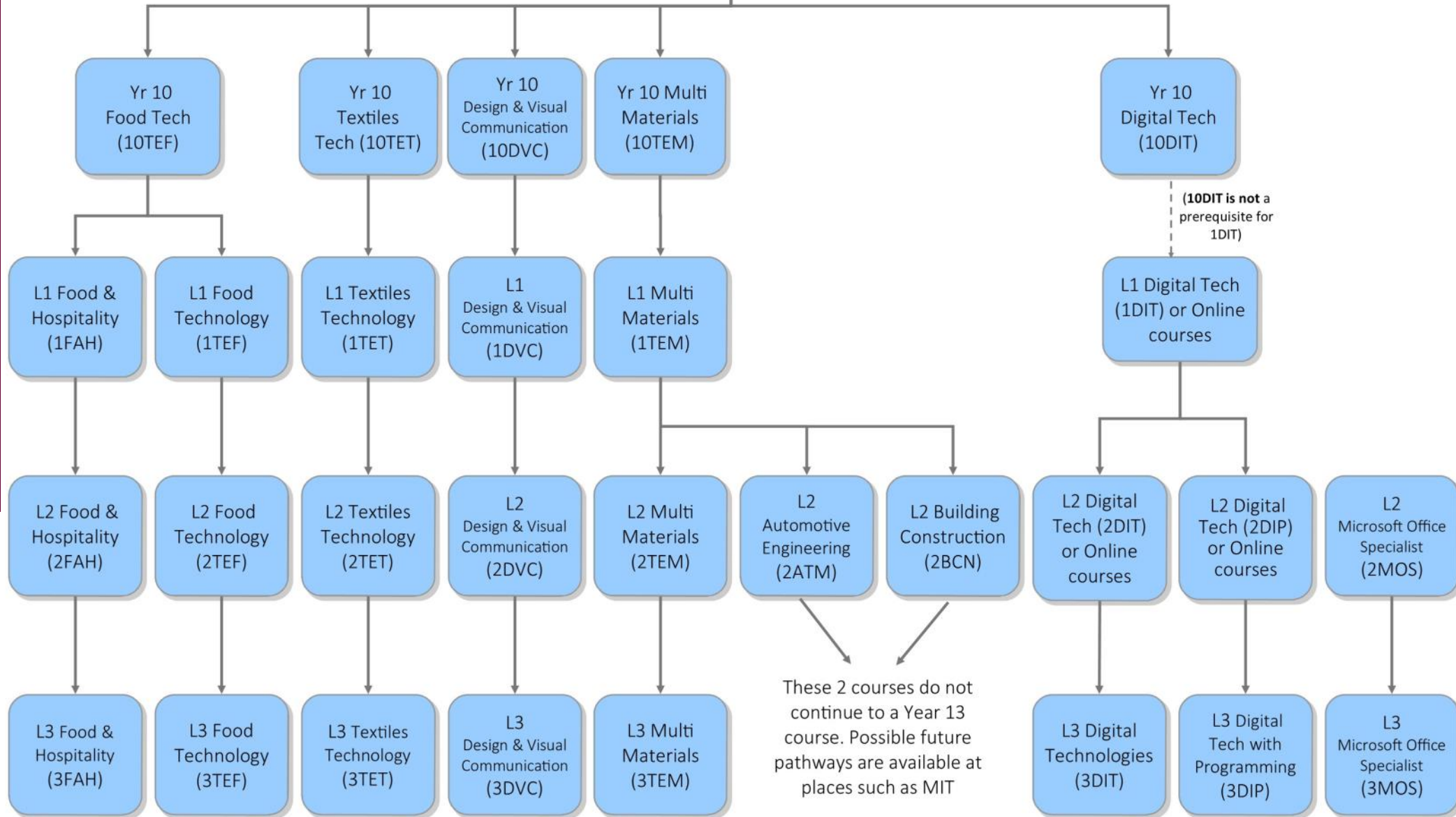

VISUAL & PERFORMING ARTS FLOWCHART 2018

Yr 9 Dance (9DAN), Drama (9DRA), Music (9MUS), Visual Art (9ART)
(1 term each)

With portfolio application
and HOLA approval
.....▶

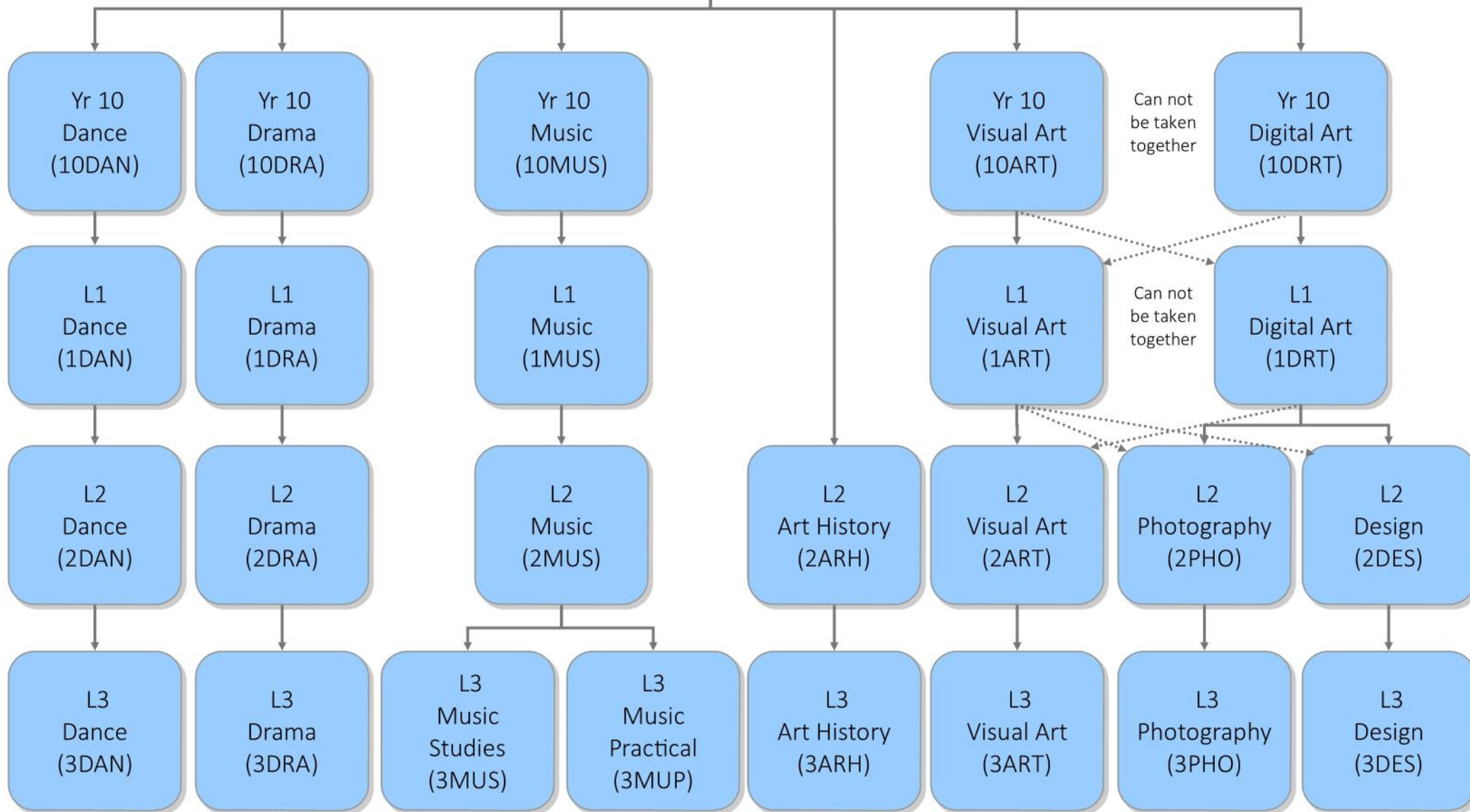

ENGLISH (2ENG)

COURSE INFORMATION

Qualification and level:	NCEA Level 2
Course Prerequisites:	At least 12 credits from Level One English
Fieldwork:	NIL
Approximate Course Costs:	NIL
Course Leads to:	NCEA Level 3 English
Course Provider/Assessor:	Botany Downs Secondary College
Teacher in charge of subject:	Ms Scott-Knight
HOLA in charge of subject:	Ms Pinnell

COURSE OUTLINE

English is compulsory at Year 12. There are 5 different Level 2 English courses. Students will be placed into the appropriate course by the Head of English according to the student's performance in Year 11 and teacher recommendation. Students do not choose this placement.

Level 2 English builds on the skills developed in Level 1 English so that students will learn to analyse more complex texts. Students will also develop greater sophistication in using language (verbal and written) for purpose and effect.

For the external assessments students will study written and visual texts. They will develop their essay writing and close reading skills for the three standards assessed in the end of year exam.

For their internal assessments students will read and respond to a range of texts, develop a writing portfolio, and conduct a close viewing of a visual text.

Five of the six Achievement Standards offered in this course contribute to University Entrance Literacy requirements.

Students will also be given the opportunity to complete an additional standard - AS91102 Construct and deliver a crafted and controlled oral text - to gain extra credits.

STANDARDS

Standards for this course will be selected from those listed below and are at the discretion of the HOLA
 Level 2 Standards that contribute to Literacy and Numeracy are indicated by (L) = Literacy; (N) = Numeracy
 Level 2 & 3 Standards that contribute to UE literacy requirements are indicated by (R) = Reading; (W) = Writing

VOCATIONAL PATHWAYS

Vocational Pathway information helps with future career planning. Each Standard has been aligned to a potential Pathway, reflected by a tick in the relevant column of the table. "What is your pathway?" Please refer to page 5 in this book or pages 22 and 23 in the Level 1-3 Information Book for more information regarding Vocational Pathways.

STANDARDS							VOCATIONAL PATHWAYS					
Number	Subject Ref	Title	Int/Ext	Credits	CODES	Construction & Infrastructure	Manufacturing & Technology	Primary Industries	Service Industries	Social & Community Services	Creative Industries	
<i>NCEA Internal Achievement Standards/Unit Standards</i>												
AS91101	English 2.4	Produce a selection of crafted and controlled writing	Internal	6	W	✓	✓	✓	✓	✓	✓	
AS91106	English 2.9	Form developed personal responses to independently read texts, supported by evidence	Internal	4	R	✓	✓	✓	✓	✓	✓	
AS91107	English 2.10	Analyse aspects of visual and/or oral text(s) through close viewing and/or listening, supported by evidence.	Internal	3		✓		✓	✓	✓	✓	
<i>NCEA External Achievement Standards</i>												
AS91098	English 2.1	Analyse specified aspect(s) of studied written texts	External	4	R/W	✓	✓	✓	✓	✓	✓	
AS91099	English 2.2	Analyse specified aspect(s) of studied visual/oral texts	External	4	W	✓	✓	✓	✓	✓	✓	
AS91100	English 2.3	Analyse significant aspects of unfamiliar written texts through close reading	External	4	R/W	✓	✓	✓	✓	✓	✓	
<i>Possible Credits Available</i>			25 Credits									
						25	22	25	25	25	25	
						<i>Total recommended ✓ credits</i>						
						<i>Total sector related ✓✓ credits</i>						

ENGLISH - ALTERNATIVE (2ENA)

COURSE INFORMATION

Qualification and level:	NCEA Level 2
Course Prerequisites:	Literacy at Level 1 or at discretion of HOLA.
Fieldwork:	NIL
Approximate Course Costs:	NIL
Course Leads to:	32ENB - Additional Level 2 standards in Year 13
Course Provider/Assessor:	Botany Downs Secondary College
Teacher in charge of subject:	Ms Scott-Knight
HOLA in charge of subject:	Ms Pinnell

COURSE OUTLINE

English is compulsory at Year 12. There are 5 different Level 2 English courses. Students will be placed into the appropriate course by the Head of English according to the student's performance in Year 11 and teacher recommendation. Students do not choose this placement.

This course is suitable for students who will need extra support and time to develop the skills needed for Level 2 English. Students will learn to analyse more complex texts and develop greater sophistication in using language (verbal and written) for purpose and effect.

Students will study written and visual texts, as well as developing their essay writing skills. Students will also read and respond to a range of texts and show their understanding through close reading and viewing.

This course provides the opportunity to gain University Entrance Literacy standards for those students who may wish to attend university in the future. There is differentiation within the course to meet the needs of students. Students may not be entered for all standards.

STANDARDS

Standards for this course will be selected from those listed below and are at the discretion of the HOLA
 Level 2 Standards that contribute to Literacy and Numeracy are indicated by (L) = Literacy; (N) = Numeracy
 Level 2 & 3 Standards that contribute to UE literacy requirements are indicated by (R) = Reading; (W) = Writing

VOCATIONAL PATHWAYS

Vocational Pathway information helps with future career planning. Each Standard has been aligned to a potential Pathway, reflected by a tick in the relevant column of the table. "What is your pathway?" Please refer to page 5 in this book or pages 22 and 23 in the Level 1-3 Information Book for more information regarding Vocational Pathways.

STANDARDS							VOCATIONAL PATHWAYS					
Number	Subject Ref	Title	Int/Ext	Credits	CODES	Construction & Infrastructure	Manufacturing & Technology	Primary Industries	Service Industries	Social & Community Services	Creative Industries	
<i>NCEA Internal Achievement Standards/Unit Standards</i>												
AS91101	English 2.4	Produce a selection of crafted and controlled writing	Internal	6	W	✓	✓	✓	✓	✓	✓	
AS91106	English 2.9	Form developed personal response to independently read texts, supported by evidence	Internal	4	R	✓	✓	✓	✓	✓	✓	
<i>NCEA External Achievement Standards</i>												
AS91098	English 2.1	Analyse specified aspect(s) of studied written texts	External	4	R/W	✓	✓	✓	✓	✓	✓	
AS91099	English 2.2	Analyse specified aspect(s) of studied visual/oral texts	External	4	W	✓	✓	✓	✓	✓	✓	
<i>Possible Credits Available</i>			18 Credits									
						<i>Total recommended ✓ credits</i>						
						18	18	18	18	15	18	
						<i>Total sector related ✓✓ credits</i>						

ENGLISH - EXTENDED (2ENE)

COURSE INFORMATION

Qualification and level:	NCEA Level 2
Course Prerequisites:	At least 18 credits from Level One English, as well as Achievement with Merit/Excellence in at least three achievement standards (including at least one external achievement standard).
Fieldwork:	NIL
Approximate Course Costs:	NIL
Course Leads to:	NCEA Level 3 English
Course Provider/Assessor:	Botany Downs Secondary College
Teacher in charge of subject:	Ms Scott-Knight
HOLA in charge of subject:	Ms Pinnell

COURSE OUTLINE

English is compulsory at Year 12. There are 5 different Level 2 English courses. Students will be placed into the appropriate course by the Head of English according to the student's performance in Year 11 and teacher recommendation. Students do not choose this placement.

Level 2 English Extended is an academic course that builds on the skills developed in Level 1 English. Students will learn to analyse more complex texts. Students will also develop greater sophistication in using language (verbal and written) for purpose and effect.

For the external assessments students will study a range of genres, including a unit of work on a Shakespeare play for written text as well as a visual text. They will develop their essay writing and close reading skills for the three standards assessed in the end of year exam.

For their internal assessments students will read and respond to a range of texts, develop a writing portfolio, and conduct a close viewing of a visual text.

Five of the six Achievement Standards offered in this course contribute to University Entrance Literacy requirements.

Students will also be given the opportunity to complete an additional standard - AS91102 Construct and deliver a crafted and controlled oral text - to gain extra credits.

Entry into this course is at HOLA discretion.

STANDARDS

Standards for this course will be selected from those listed below and are at the discretion of the HOLA
 Level 2 Standards that contribute to Literacy and Numeracy are indicated by (L) = Literacy; (N) = Numeracy
 Level 2 & 3 Standards that contribute to UE literacy requirements are indicated by (R) = Reading; (W) = Writing

VOCATIONAL PATHWAYS

Vocational Pathway information helps with future career planning. Each Standard has been aligned to a potential Pathway, reflected by a tick in the relevant column of the table. "What is your pathway?" Please refer to page 5 in this book or pages 22 and 23 in the Level 1-3 Information Book for more information regarding Vocational Pathways.

STANDARDS							VOCATIONAL PATHWAYS					
Number	Subject Ref	Title	Int/Ext	Credits	CODES	Construction & Infrastructure	Manufacturing & Technology	Primary Industries	Service Industries	Social & Community Services	Creative Industries	
<i>NCEA Internal Achievement Standards/Unit Standards</i>												
AS91101	English 2.4	Produce a selection of crafted and controlled writing	Internal	6	W	✓	✓	✓	✓	✓	✓	
AS91106	English 2.9	Form developed personal response to independently read texts, supported by evidence	Internal	4	R	✓	✓	✓	✓	✓	✓	
AS91107	English 2.10	Analyse aspects of visual and/or oral text(s) through close viewing and/or listening, supported by evidence	Internal	3							✓	
<i>NCEA External Achievement Standards</i>												
AS91098	English 2.1	Analyse specified aspect(s) of studied written texts	External	4	R/W	✓	✓	✓	✓	✓	✓	
AS91099	English 2.2	Analyse specified aspect(s) of studied visual/oral texts	External	4	W	✓	✓	✓	✓	✓	✓	
AS91100	English 2.3	Analyse significant aspects of unfamiliar written texts through close reading	External	4	R/W	✓	✓	✓	✓	✓	✓	
				<i>Possible Credits Available</i>								
				25 Credits								
				<i>Total recommended ✓ credits</i>		22	22	22	22	22	25	
				<i>Total sector related ✓✓ credits</i>								

ENGLISH as an ADDITIONAL LANGUAGE (2ENP)

COURSE INFORMATION

Qualification and level:	NCEA Level 2
Course Prerequisites:	By recommendation of HOD of EAL
Fieldwork:	NIL
Approximate Course Costs:	NIL
Course Leads to:	NCEA Level 2 English (12ENP - 2nd year)
Course Provider/Assessor:	Botany Downs Secondary College
Teacher in charge of subject:	Mrs Narain
HOLA in charge of subject:	Mrs Narain

COURSE OUTLINE

English is compulsory at Year 12. There are 5 different Level 2 English courses. Students will be placed into the appropriate course by the Head of English according to the student's performance in Year 11 and teacher recommendation. Students do not choose this placement.

This course builds on 1ENP to provide less proficient students with the skills to complete some of the Level 2 English standards. This course will be completed over two years. The focus will be on developing student's speaking, listening, reading and writing with specific focus on improving vocabulary and grammar.

For their external assessments students will complete study on short and extended written texts as well as a visual text. They will develop their essay writing skills for AS2.1 and AS2.2 in the 2nd year.

For their internal assessments students will complete a set of reading logs on a range of texts and construct and deliver a crafted and controlled oral text.

STANDARDS

Standards for this course will be selected from those listed below and are at the discretion of the HOLA
 Level 2 Standards that contribute to Literacy and Numeracy are indicated by (L) = Literacy; (N) = Numeracy
 Level 2 & 3 Standards that contribute to UE literacy requirements are indicated by (R) = Reading; (W) = Writing

VOCATIONAL PATHWAYS

Vocational Pathway information helps with future career planning. Each Standard has been aligned to a potential Pathway, reflected by a tick in the relevant column of the table. "What is your pathway?" Please refer to page 5 in this book or pages 22 and 23 in the Level 1-3 Information Book for more information regarding Vocational Pathways.

STANDARDS						VOCATIONAL PATHWAYS					
Number	Subject Ref	Title	Int/Ext	Credits	CODES	Construction & Infrastructure	Manufacturing & Technology	Primary Industries	Service Industries	Social & Community Services	Creative Industries
<i>NCEA Internal Achievement Standards/Unit Standards</i>											
AS91106	English 2.9	Form developed personal responses to independently read texts, supported by evidence	Internal	4	R	✓	✓	✓	✓	✓	✓
AS91101	English 2.4	Produce a selection of crafted and controlled writing	Internal	6	W	✓	✓	✓	✓	✓	✓
<i>NCEA External Achievement Standards</i>											
AS91098	English 2.1	Analyse specified aspect(s) of studied written text(s), with supporting evidence	External	4	R/W	✓	✓	✓	✓	✓	✓
AS91099	English 2.2	Analyse specified aspect(s) of studied visual or oral text(s), with supporting evidence	External	4	W	✓	✓	✓	✓	✓	✓
<i>Possible Credits Available</i>			18 Credits								
						18	18	18	18	18	18
						<i>Total recommended ✓ credits</i>					
						<i>Total sector related ✓✓ credits</i>					

ENGLISH as an ADDITIONAL LANGUAGE (2ENS)

COURSE INFORMATION

Qualification and level:	NCEA Level 2
Course Prerequisites:	By recommendation of HOD of EAL
Fieldwork:	NIL
Approximate Course Costs:	NIL
Course Leads to:	3ENG, 32ENB
Course Provider/Assessor:	Botany Downs Secondary College
Teacher in charge of subject:	Mrs Narain
HOLA in charge of subject:	Mrs Narain

COURSE OUTLINE

English is compulsory at Year 12. There are 5 different Level 2 English courses. Students will be placed into the appropriate course by the Head of English according to the students performance in Year 11 and teacher recommendation. Students do not choose this placement.

This is a course which offers the opportunity to develop the four skills necessary for English Language Learners. Students will develop skills in reading, writing, speaking and listening through standards which link to NCEA Level 2 English. Study will be similar to that at Level 1. However, literature studied is more advanced and students will need to be able to analyse the texts studied rather than simply describe and explain.

For their external assessments students will complete study on short and extended written texts as well as a visual text. They will develop their essay writing skills for AS2.1 and AS2.2.

For their internal assessments students will complete a set of reading logs on a range of texts and develop a writing portfolio over at least two terms and then from this, publish their two pieces of writing.

Students should also note that entry into Level 3 English, if they wish to continue with the subject after Year 12, requires at least 10 credits (5 reading and 5 writing) including passes in two of the external papers.

STANDARDS

Standards for this course will be selected from those listed below and are at the discretion of the HOLA
 Level 2 Standards that contribute to Literacy and Numeracy are indicated by (L) = Literacy; (N) = Numeracy
 Level 2 & 3 Standards that contribute to UE literacy requirements are indicated by (R) = Reading; (W) = Writing

VOCATIONAL PATHWAYS

Vocational Pathway information helps with future career planning. Each Standard has been aligned to a potential Pathway, reflected by a tick in the relevant column of the table. "What is your pathway?" Please refer to page 5 in this book or pages 22 and 23 in the Level 1-3 Information Book for more information regarding Vocational Pathways.

STANDARDS							VOCATIONAL PATHWAYS					
Number	Subject Ref	Title	Int/Ext	Credits	CODES	Construction & Infrastructure	Manufacturing & Technology	Primary Industries	Service Industries	Social & Community Services	Creative Industries	
<i>NCEA Internal Achievement Standards/Unit Standards</i>												
AS91101	English 2.4	Produce a selection of crafted and controlled writing	Internal	6	W	✓	✓	✓	✓	✓	✓	
AS91104	English 2.9	Form developed personal responses to independently read texts, supported by evidence	Internal	4	R	✓	✓	✓	✓	✓	✓	
<i>NCEA External Achievement Standards</i>												
AS91098	English 2.1	Analyse specified aspect(s) of studied written texts	External	4	R/W	✓	✓	✓	✓	✓	✓	
AS91099	English 2.2	Analyse specified aspect(s) of studied visual/oral texts	External	4	W	✓	✓	✓	✓	✓	✓	
<i>Possible Credits Available</i>			18 Credits									
						18	18	18	18	18	18	
						<i>Total recommended ✓ credits</i>						
						<i>Total sector related ✓✓ credits</i>						

ACCOUNTING (2ACC)

COURSE INFORMATION

Qualification and level:	NCEA Level 2
Course Prerequisites:	12 credits in NCEA Level 1 Accounting
Fieldwork:	NIL
Approximate Course Costs:	Approximately \$60 for workbook ,Education Perfect and online resources Approximately \$30 for trips
Course Leads to:	Mandatory for NCEA Level 3 Accounting, links to all business subjects
Course Provider/Assessor:	Botany Downs Secondary College
Teacher in charge of subject:	Mrs McArthur
HOLA in charge of subject:	Mr Andrew

COURSE OUTLINE

Level 2 Accounting builds on the foundation that is Level 1 into a course that is both practical and academic. Students will deepen their understanding of accounting as they move their focus to larger entities. They will make use of appropriate communication tools, such as the professional accounting software package MYOB, and their skills, to process, report and interpret information for individuals and sole proprietors that operate accounting sub-systems.

STANDARDS

Standards for this course will be selected from those listed below and are at the discretion of the HOLA
 Level 2 Standards that contribute to Literacy and Numeracy are indicated by (L) = Literacy; (N) = Numeracy
 Level 2 & 3 Standards that contribute to UE literacy requirements are indicated by (R) = Reading; (W) = Writing

VOCATIONAL PATHWAYS

Vocational Pathway information helps with future career planning. Each Standard has been aligned to a potential Pathway, reflected by a tick in the relevant column of the table. "What is your pathway?" Please refer to page 5 in this book or pages 22 and 23 in the Level 1-3 Information Book for more information regarding Vocational Pathways.

STANDARDS						VOCATIONAL PATHWAYS							
Number	Subject Ref	Title	Int/Ext	Credits	CODES	Construction & Infrastructure	Manufacturing & Technology	Primary Industries	Service Industries	Social & Community Services	Creative Industries		
<i>NCEA Internal Achievement Standards/Unit Standards</i>													
AS91175	Acc 2.2	Demonstrate understanding of accounting processing using accounting software	Internal	4	N				✓		✓		
AS91179	Acc 2.6	Demonstrate understanding of an accounts receivable subsystem	Internal	3	L/N						✓		
AS91386	Acc 2.7	Demonstrate understanding of an inventory subsystem for an entity	Internal	3	L/N								
<i>NCEA External Achievement Standards</i>													
AS91176	Acc 2.3	Prepare financial information for an entity that operates accounting subsystems	External	5	N						✓		
AS91177	Acc 2.4	Interpret accounting information for entities that operate accounting subsystems	External	4	L/N						✓		
<i>Possible Credits Available</i>			19 Credits										
						<i>Total recommended ✓ credits</i>			4	<i>Total sector related ✓✓ credits</i>			16

ART HISTORY (2ARH)

COURSE INFORMATION

Qualification and level:	NCEA Level 2
Course Prerequisites:	Minimum of 12 Level 1 Literacy credits or HOLA discretion
Fieldwork:	A gallery trip and/or a trip to Auckland University's art history department
Approximate Course Costs:	Approximately \$40 for two trips and \$60 for course workbooks.
Course Leads to:	NCEA Level 3 Art History and Scholarship
Course Provider/Assessor:	Botany Downs Secondary College
Teacher in charge of subject:	Miss Henshaw
HOLA in charge of subject:	Miss Clapperton

COURSE OUTLINE

Much scholarly debate has been dedicated to the argument 'does art imitate life, or life imitate art?'. Through the study of Art History students will have the opportunity to study works of art in detail, focusing not only on the techniques used to create the work, but also the cultural, social and historical context in which the work was produced. Students will have the opportunity to analyse artistic techniques, research works of art as they appear in their social and environmental contexts, examine subjects and themes in art and develop the analytical skills needed to discuss a given work of art. The contexts studied are within the topic of Western art forms from 20th Century Europe. It is recommended that students choosing to take this course have access to their own digital device to use for research, as this forms a large component of the three internal assessments.

STANDARDS

Standards for this course will be selected from those listed below and are at the discretion of the HOLA
 Level 2 Standards that contribute to Literacy and Numeracy are indicated by (L) = Literacy; (N) = Numeracy
 Level 2 & 3 Standards that contribute to UE literacy requirements are indicated by (R) = Reading; (W) = Writing

VOCATIONAL PATHWAYS

Vocational Pathway information helps with future career planning. Each Standard has been aligned to a potential Pathway, reflected by a tick in the relevant column of the table. "What is your pathway?" Please refer to page 5 in this book or pages 22 and 23 in the Level 1-3 Information Book for more information regarding Vocational Pathways.

STANDARDS							VOCATIONAL PATHWAYS					
Number	Subject Ref	Title	Int/Ext	Credits	CODES	Construction & Infrastructure	Manufacturing & Technology	Primary Industries	Service Industries	Social & Community Services	Creative Industries	
<i>NCEA Internal Achievement Standards/Unit Standards</i>												
AS91183	Art His 2.4	Examine how media are used to create effects in art works	Internal	4	L				✓		✓✓	
AS91184	Art His 2.5	Communicate understanding of an art history topic	Internal	4	L						✓✓	
AS91185	Art His 2.6	Communicate a considered personal response to art works	Internal	4	L						✓	
<i>NCEA External Achievement Standards</i>												
AS91180	Art His 2.1	Examine the effects of formal elements of art works	External	4	L						✓✓	
AS91181	Art His 2.2	Examine the meanings conveyed by art works	External	4	L				✓		✓✓	
AS91182	Art His 2.3	Examine the influence of context(s) on art works	External	4	L						✓✓	
				<i>Possible Credits Available</i>								
				24 Credits								
							<i>Total recommended ✓ credits</i>		8		4	
							<i>Total sector related ✓✓ credits</i>		20			

AUTOMOTIVE ENGINEERING (2ATM)

COURSE INFORMATION

Qualification and level:	NCEA Level 2
Course Prerequisites:	Students who have completed a course in Level 1 Technology or Graphics or through Head of Subject approval.
Fieldwork:	MIT TRADES ACADEMY EVERY FRIDAY ALL DAY
Approximate Course Costs:	Take home component \$80
Course Leads to:	Certificate in Automotive Engineering and the introduction to other Engineering fields
Course Provider/Assessor:	Botany Downs Secondary College
Teacher in charge of subject:	Mr Jowers-Wilding
HOLA in charge of subject:	Mr Achary

COURSE OUTLINE

This course is aimed at students who would like to further their skills in the areas of Automotive and General Engineering. It is also aimed at students who are interested in a career path related to Automotive and a wide range of Engineering fields. Part of this course will be conducted at Manukau Institute of Technology and students will become part of the TRADES ACADEMY, and will attend MIT EVERY FRIDAY. They will be expected to catch up with lessons missed. All costs associated with the Trades Academy will be met by the school.

The course contains Level 2 unit standards in the areas of Automotive and Engineering. As part of the course students will learn about two stroke and four stroke petrol and diesel engines, along with the functions of the motor vehicle and its main components. Oxy-acetylene welding and engineering skills are also part of the course.

Maximum numbers in each of these classes will be 20 due to the practical nature of this course and **constraints imposed by MIT.**

Please note students can not take both Automotive Engineering (2ATM) and Building Construction (2BCN).

STANDARDS

Standards for this course will be selected from those listed below and are at the discretion of the HOLA
 Level 2 Standards that contribute to Literacy and Numeracy are indicated by (L) = Literacy; (N) = Numeracy
 Level 2 & 3 Standards that contribute to UE literacy requirements are indicated by (R) = Reading; (W) = Writing

VOCATIONAL PATHWAYS

Vocational Pathway information helps with future career planning. Each Standard has been aligned to a potential Pathway, reflected by a tick in the relevant column of the table. "What is your pathway?" Please refer to page 5 in this book or pages 22 and 23 in the Level 1-3 Information Book for more information regarding Vocational Pathways.

STANDARDS						VOCATIONAL PATHWAYS					
Number	Subject Ref	Title	Int/Ext	Credits	CODES	Construction & Infrastructure	Manufacturing & Technology	Primary Industries	Service Industries	Social & Community Services	Creative Industries
<i>NCEA Internal Unit Standards Taught and Assessed at BDSC</i>											
21685/ 21682	-	The use an oxy-acetylene welding plant in the motor industry	Int	5			✓✓				
21671	-	Demonstrate practical knowledge of general engineering tasks in the motor industry	Int	4			✓✓				
21684	-	Use a MIG welding plant in the motor industry	Int	3			✓✓				
<i>NCEA Internal Unit Standards Taught and Assessed at M.I.T</i>											
21674	-	Demonstrate knowledge of terminology used in the motor industry	Int	2			✓✓				
21669	-	Demonstrate knowledge of hand tools and workshop equipment for motor industry applications	Int	2			✓✓				
16113	-	Demonstrate a knowledge of safe working practices in an automotive workshop	Int	2			✓✓				
231	-	Explain the operation of two and four stroke petrol and diesel engines	Int	4			✓✓				
21691	-	Disassemble and reassemble a single cylinder or multi-cylinder four stroke engine under supervision	Int	2			✓✓				
21690	-	Perform general servicing checks on a motor vehicle	Int	3			✓✓				
21667	-	Demonstrate knowledge of testing automotive electrical circuits	Int	3			✓✓				
21857	-	Identify the occupational areas and structure of New Zealand Motor industry	Int	2			✓✓				
21707	-	Demonstrate knowledge of automotive electrical principles	Int	6			✓✓				
3877	-	Demonstrate knowledge of protecting vehicle electronics in the motor industry	Int	2			✓✓				
233	-	Service an automotive battery	Int	2			✓✓				
21719	-	Remove and replace motor vehicle lamps in the motor industry	Int	1			✓✓				
				<i>Possible Credits Available</i>	43 Credits						
							43				

BIOLOGY (2BIO)

COURSE INFORMATION

Qualification and level:	NCEA Level 2
Course Prerequisites:	Passed NCEA Level 1 Science Achievement Standards AS90948 and AS90926 and 12 credits NCEA Level 1 Achievement Standards in English.
Approximate Course Costs:	\$20.00 Education perfect online resources.
Course Leads to:	NCEA Level 3 Biology (3BIO or 3BIA)
Course Provider/Assessor:	Botany Downs Secondary College
Teacher in charge of subject:	Mrs Husted
HOLA in charge of subject:	Mr Kumar

COURSE OUTLINE

Biology is the study of the variety, structure, functions, continuity and interrelationships of living things in nature. This course covers the key basics of cell biology, researching adaptations in animals that enable them to carry out living processes and deepening students understanding of genetics. It provides a wide range of learning experiences which will be of value to all students throughout their lives, and provides a sound foundation to the study of biological and health sciences in the future. The internal assessment component of the course allows students to develop skills to analyse biological validity and also allows them to become familiar with science current affairs with a New Zealand focus. Research skills will also be developed to demonstrate an understanding of adaptations in plants and animals.

It is important to note that this course is a prerequisite if students are intending to take Biology in Year 13 (BIO) the following year.

Students that do not meet the prerequisites for Level 2 Biology (2BIO) but who still desire to study Biology at NCEA Level 2 can consider a modified Y12 course (2BIA).

STANDARDS

Standards for this course will be selected from those listed below and are at the discretion of the HOLA
 Level 2 Standards that contribute to Literacy and Numeracy are indicated by (L) = Literacy; (N) = Numeracy
 Level 2 & 3 Standards that contribute to UE literacy requirements are indicated by (R) = Reading; (W) = Writing

VOCATIONAL PATHWAYS

Vocational Pathway information helps with future career planning. Each Standard has been aligned to a potential Pathway, reflected by a tick in the relevant column of the table. "What is your pathway?" Please refer to page 5 in this book or pages 22 and 23 in the Level 1-3 Information Book for more information regarding Vocational Pathways.

STANDARDS						VOCATIONAL PATHWAYS					
Number	Subject Ref	Title	Int/Ext	Credits	CODES	Construction & Infrastructure	Manufacturing & Technology	Primary Industries	Service Industries	Social & Community Services	Creative Industries
<i>NCEA Internal Achievement Standards/Unit Standards</i>											
AS91154	Biology 2.2	Analyse the biological validity of information presented to the public	Internal	3	L			✓		✓	
AS91155	Biology 2.3	Demonstrate understanding of adaptation of plants and animals to their way of life	Internal	3	L			✓	✓	✓	
<i>NCEA External Achievement Standards</i>											
AS91156	Biology 2.4	Demonstrate understanding of life processes at the cellular level	External	4	L			✓		✓	
AS91157	Biology 2.5	Demonstrate understanding of genetic variation and change	External	4	L			✓		✓	
AS91159	Biology 2.7	Demonstrate understanding of gene expression	External	4	L			✓		✓	
<i>Possible Credits Available</i>			18 Credits								
							4	18	3	18	
						<i>Total recommended ✓ credits</i>					
						<i>Total sector related ✓✓ credits</i>					

BIOLOGY - ALTERNATIVE (2BIA)

COURSE INFORMATION

Qualification and level:	NCEA Level 2
Course Prerequisites:	Pass NCEA Level 1 Science Achievement Standards AS90948 or AS90926 and 8 credits (NCEA Level 1 Achievement Standards) in English.
Approximate Course Costs:	\$20.00 Education perfect online resources.
Course Leads to:	NCEA Level 3 Biology Alternative (3BIA)
Course Provider/Assessor:	Botany Downs Secondary College
Teacher in charge of subject:	Mrs Darby
HOLA in charge of subject:	Mr Kumar

COURSE OUTLINE

This course is structured for students that do not meet the prerequisites for Level 2 Biology (2BIO) but who still desire to study Biology at NCEA Level 2. This provides a pathway into Level 3 Biology Alternative course (3BIA). This course is limited to students who do not meet the prerequisites for 2BIO.

Biology is the study of the variety, structure, functions, continuity and interrelationships of living things in nature. This course covers the key basics of cell biology, researching adaptations in animals that enable them to carry out living processes and deepening students understanding of genetics. It provides a wide range of learning experiences which will be of value to all students throughout their lives, and provides a sound foundation to the study of biological and health sciences in the future. The internal assessment component of the course allows students to develop practical biological and transferable skills and also allows them to become familiar with science current affairs with a New Zealand focus.

It is important to note that this course is a prerequisite if students are intending to take Biology in Year 13 (3BIA) the following year.

STANDARDS

Standards for this course will be selected from those listed below and are at the discretion of the HOLA
 Level 2 Standards that contribute to Literacy and Numeracy are indicated by (L) = Literacy; (N) = Numeracy
 Level 2 & 3 Standards that contribute to UE literacy requirements are indicated by (R) = Reading; (W) = Writing

VOCATIONAL PATHWAYS

Vocational Pathway information helps with future career planning. Each Standard has been aligned to a potential Pathway, reflected by a tick in the relevant column of the table. "What is your pathway?" Please refer to page 5 in this book or pages 22 and 23 in the Level 1-3 Information Book for more information regarding Vocational Pathways.

STANDARDS						VOCATIONAL PATHWAYS					
Number	Subject Ref	Title	Int/Ext	Credits	CODES	Construction & Infrastructure	Manufacturing & Technology	Primary Industries	Service Industries	Social & Community Services	Creative Industries
<i>NCEA Internal Achievement Standards/Unit Standards</i>											
AS91153	Biology 2.1	Carry out a practical investigation in a biology context, with supervision	Internal	4	N		✓	✓	✓	✓	
AS91154	Biology 2.2	Analyse the biological validity of information presented to the public	Internal	3	L			✓	✓	✓	
AS91155	Biology 2.3	Demonstrate understanding of adaptation of plants and animals to their way of life	Internal	3	L			✓	✓	✓	
AS91160	Biology 2.8	Investigate biological material at the microscopic level	Internal	3				✓	✓	✓	
<i>NCEA External Achievement Standards</i>											
AS91156	Biology 2.4	Demonstrate understanding of life processes at the cellular level	External	4	L			✓	✓	✓	
AS91157	Biology 2.5	Demonstrate understanding of genetic variation and change	External	4	L			✓	✓	✓	
				<i>Possible Credits Available</i>							
				22							
						<i>Total recommended ✓ credits</i>					
						4 21 10 21					
						<i>Total sector related ✓✓ credits</i>					
						4 21 10 21					

BUILDING CONSTRUCTION (2BCN)

COURSE INFORMATION

Qualification and level:	NCEA Level 2
Course Prerequisites:	This course is designed for only those students who are certain that they will be pursuing a building career.
Fieldwork:	Students will attend MIT Trades Academy every FRIDAY
Approximate Course Costs:	Take home component \$40
Course Leads to:	Building Course at MIT
Course Provider/Assessor:	BCITO, MIT
Teacher in charge of subject:	Mr Achary
HOLA in charge of subject:	Mr Achary

COURSE OUTLINE

This course is aimed at students who would like to pursue a career in the building industry. It creates a pathway for students to courses available at MIT. The project provides opportunity for a rich, authentic learning experience for students. Students have the opportunity to plan, sketch, draw, determine quantities, construct and monitor construction. Students will engage in practical building skills as well as researching products and regulations online; planning the building process and studying the building industry.

Part of this course will be conducted at Manukau Institute of Technology and students will become part of the TRADES ACADEMY, and will attend MIT EVERY FRIDAY. They will be expected to catch up with lessons missed. All costs associated with attending the Trades Academy will be met by the school.

Maximum numbers in each of these classes will be 20 due to the practical nature of this course and **constraints imposed by MIT.**

Please note students can not take both Automotive Engineering (2ATM) and Building Construction (2BCN).

If students are successful in all of the below Standards, and attain one Standard in English, they will be offered one additional standard to complete the 'National Certificate In Building, Construction and Allied Trades Skills Level 2'

STANDARDS

Standards for this course will be selected from those listed below and are at the discretion of the HOLA
 Level 2 Standards that contribute to Literacy and Numeracy are indicated by (L) = Literacy; (N) = Numeracy
 Level 2 & 3 Standards that contribute to UE literacy requirements are indicated by (R) = Reading; (W) = Writing

VOCATIONAL PATHWAYS

Vocational Pathway information helps with future career planning. Each Standard has been aligned to a potential Pathway, reflected by a tick in the relevant column of the table. "What is your pathway?" Please refer to page 5 in this book or pages 22 and 23 in the Level 1-3 Information Book for more information regarding Vocational Pathways.

STANDARDS						VOCATIONAL PATHWAYS					
Number	Subject Ref	Title	Int/Ext	Credits	CODES	Construction & Infrastructure	Manufacturing & Technology	Primary Industries	Service Industries	Social & Community Services	Creative Industries
<i>NCEA Internal Unit Standards Taught and Assessed at BDSC</i>											
US12932	Building	Construct timber garden furniture and items of basic construction equipment as a basic BCATS project	Int	8		✓✓					
US24358	Building	Plan and monitor the construction of a BCATS project and quality check the product	Int	2		✓✓					
US24350	Building	Identify, select, use and maintain portable power tools for BCATS projects	Int	6		✓✓					
US24357	Building	Receive instructions and communicate information in a BCATS environment	Int	4		✓✓					
<i>NCEA Internal Unit Standards Taught and Assessed at MIT</i>											
US12927	Building	Identify, select, maintain and use hand tools for BCATS projects	Int	6		✓✓					
US24354	Building	Demonstrate knowledge of and apply safe working practices in a BCATS workplace	Int	4		✓✓					
US24360	Building	Demonstrate knowledge of timber and other construction materials used in a BCATS projects	Int	5		✓✓		✓			
US750	Electrical	Demonstrate knowledge of electrical test instruments and take measurements	Int	2		✓✓	✓✓				
US15851	Electrical	Demonstrate knowledge of electrical safety and safe working practices for electrical workers	Int	3		✓✓	✓✓				
US15852	Electrical	Isolate and test low-voltage electrical sub-circuits	Int	2		✓✓					
US15844	Electrical	Select and install flexible cords	Int	3		✓✓					
US18275	Electrical	Demonstrate knowledge of the NZ electricity supply industry	Int	2							
				<i>Possible Credits Available</i>							
				47 Credits							
				<i>Total recommended ✓✓ credits</i>							
				<i>Total sector related ✓✓ credits</i>		45	5	5			

BUSINESS STUDIES (2BUS)

COURSE INFORMATION

Qualification and level: NCEA Level 2
 Course Prerequisites: 12 NCEA credits at Level 1 Business Studies (including one external) and the required Literacy and Numeracy Credits at NCEA Level 1 or at the discretion of HOD Commerce.
 Fieldwork: In this Business Studies Activity you will be carrying out and reviewing a business activity in groups and with guidance and direction from your teacher. You will be working with your group for approximately 9 weeks and your progress will be checked at several points.
 Approximate Course Costs: Approximately \$30 for EOTC; to be confirmed
 Course Leads to: This course provides students with the skills and content knowledge to continue with Level 3 Business contributing credits to NCEA Level 3.
 Course Provider/Assessor: Botany Downs Secondary College
 Teacher in charge of subject: Mr Sharma
 HOLA in charge of subject: Mr Andrew

COURSE OUTLINE

Business education enables students to experience the realities of business through a practical approach. Theory is supported through the application of knowledge and skills in a real business setting. This course aims to develop essential skills necessary for running and managing a small business. It is not necessary to have studied Business Studies previously. This course prepares students to continue in this field of study at NCEA Level 3. For more information regarding this course and progression through to tertiary education, please see Mr Sharma.

STANDARDS

Standards for this course will be selected from those listed below and are at the discretion of the HOLA
 Level 2 Standards that contribute to Literacy and Numeracy are indicated by (L) = Literacy; (N) = Numeracy
 Level 2 & 3 Standards that contribute to UE literacy requirements are indicated by (R) = Reading; (W) = Writing

VOCATIONAL PATHWAYS

Vocational Pathway information helps with future career planning. Each Standard has been aligned to a potential Pathway, reflected by a tick in the relevant column of the table. "What is your pathway?" Please refer to page 5 in this book or pages 22 and 23 in the Level 1-3 Information Book for more information regarding Vocational Pathways.

STANDARDS						VOCATIONAL PATHWAYS					
Number	Subject Ref	Title	Int/Ext	Credits	CODES	Construction & Infrastructure	Manufacturing & Technology	Primary Industries	Service Industries	Social & Community Services	Creative Industries
<i>NCEA Internal Achievement Standards/Unit Standards</i>											
AS90846	Business Studies 2.4	Conduct market research for a new or existing product	Internal	3	L/N			✓	✓		✓
AS90848	Business Studies 2.6	Carry out, review and refine a business activity within a community context with guidance	Internal	9	L						✓
<i>NCEA External Achievement Standards</i>											
AS90843	Business Studies 2.1	Demonstrate an understanding of internal operations in a large business	External	4	L			✓	✓		✓
AS90844	Business Studies 2.2	understanding of how a large business responds to the effects of external factors	External	4	L			✓	✓		✓
<i>Possible Credits Available</i>			20 Credits								
						<i>Total recommended ✓ credits</i>					
						11 11 20					
						<i>Total sector related ✓✓ credits</i>					

CALCULUS - ACCELERATED (3MAX)

COURSE INFORMATION

Qualification and level:	NCEA Level 3
Course Prerequisites:	Merit or better in AS 2.6 - Algebra , AS 2.7 - Calculus and Merit or better in AS 2.4 Trigonometry or AS 2.2 Graphs.
Fieldwork:	Nil
Approximate Course Costs:	Workbook \$35, FX9750GII Casio Graphic calculator -approximately \$120 is compulsory Scholarship workbook – approximately \$25
Course Leads to:	This course will lead to University courses in engineering, sciences and any field where mathematical analysis is important.
Course Provider/Assessor:	Botany Downs Secondary College
Teacher in charge of subject:	Mr Lin
HOLA in charge of subject:	Ms Bennet

COURSE OUTLINE

This NCEA Level 3 course will assess all five Calculus Level 3 Achievement Standards giving a total of 27 credits. The aims of the standards are to consolidate and extend students' ability in algebraic, graphical and computations skills, to extend students' ability to formulate problems in mathematical terms and advance students' understanding of the nature of mathematical reasoning. This highly academic course also enables students to work towards scholarship level.

STANDARDS

Standards for this course will be selected from those listed below and are at the discretion of the HOLA
 Level 2 Standards that contribute to Literacy and Numeracy are indicated by (L) = Literacy; (N) = Numeracy
 Level 2 & 3 Standards that contribute to UE literacy requirements are indicated by (R) = Reading; (W) = Writing

VOCATIONAL PATHWAYS

Vocational Pathway information helps with future career planning. Each Standard has been aligned to a potential Pathway, reflected by a tick in the relevant column of the table. "What is your pathway?" Please refer to page 5 in this book or pages 22 and 23 in the Level 1-3 Information Book for more information regarding Vocational Pathways.

STANDARDS						VOCATIONAL PATHWAYS					
Number	Subject Ref	Title	Int/Ext	Credits	CODES	Construction & Infrastructure	Manufacturing & Technology	Primary Industries	Service Industries	Social & Community Services	Creative Industries
<i>NCEA Internal Achievement Standards/Unit Standards</i>											
AS91587	Mathematics 3.15	Apply systems of simultaneous equations in solving problems	Internal	3		✓	✓	✓			
AS91575	Mathematics 3.3	Apply trigonometric methods in solving problems	Internal	4		✓	✓				
AS91574	Mathematics 3.2	Apply linear programming methods in solving problems	Internal	3		✓	✓	✓			
<i>NCEA External Achievement Standards</i>											
AS91577	Mathematics 3.5	Apply the algebra of complex numbers in solving problems	External	5							
AS91578	Mathematics 3.6	Apply differentiation methods in solving problems	External	6		✓	✓	✓		✓	
AS91579	Mathematics 3.7	Apply integration methods in solving problems	External	6		✓	✓	✓			
<i>Possible Credits Available</i>			27 Credits								
<i>Total recommended ✓✓ credits</i>						22	22	18		6	
<i>Total sector related ✓✓ credits</i>											

CAREER PATHWAYS (2CAP)

COURSE INFORMATION

Qualification and level:	NCEA Level 2
Course Prerequisites:	None, however, students MUST have approval for this course from having an interview with the Vocational Pathways Manager. Further consultation with a member of the Senior Leadership Team or their Whanau Leader is also recommended before final placement in this course.
Fieldwork:	A work experience placement through the Gateway programme may be undertaken during the year. Students selected will be required to complete 30-40 hours of un-paid work experience in a relevant setting during the April or July holidays.
Approximate Course Costs:	Nil
Course Leads to:	Employment, apprenticeship, or further education.
Course Provider/Assessor:	Botany Downs Secondary College
Teacher in charge of subject:	Ms Stewart (Vocational Pathways Manager)
HOLA in charge of subject:	-

COURSE OUTLINE

The Career Pathways course is a generic vocational programme designed to equip students with life and communication skills which will help them when they leave school. There is an emphasis on reading and writing skills in these standards. The content of this course will be customised according to the needs of the cohort. The course is designed to improve relevance of learning for students and to provide support and guidance as they explore their future career options.

All students will be considered for the Gateway programme as part of their course. Selection and work placements will vary, depending on students interests and the availability of places. Gateway provides valuable on-the-job learning opportunities whilst allowing students to make significant progress towards qualifications.

Students who are successful in being selected for the Gateway programme will gain additional credits through this work experience programme, and units will be determined by the type of placement undertaken. Gateway provides opportunities in a range of fields including, but not limited to: Retail, Hospitality, Banking, Fashion, Hair and Beauty, Automotive, Electrical, Health and Child Care.

STANDARDS

Standards for this course are likely to be selected from those listed below although these will be at the discretion of the TIC.

Level 2 Standards that contribute to Literacy and Numeracy are indicated by (L) = Literacy; (N) = Numeracy
Level 2 & 3 Standards that contribute to UE literacy requirements are indicated by (R) = Reading; (W) = Writing

VOCATIONAL PATHWAYS

Vocational Pathway information helps with future career planning. Each Standard has been aligned to a potential Pathway, reflected by a tick in the relevant column of the table. "What is your pathway?" Please refer to page 5 in this book or pages 22 and 23 in the Level 1-3 Information Book for more information regarding Vocational Pathways.

STANDARDS						VOCATIONAL PATHWAYS							
Number	Subject Ref	Title	Int/Ext	Credits	CODES	Construction & Infrastructure	Manufacturing & Technology	Primary Industries	Service Industries	Social & Community Services	Creative Industries		
<i>NCEA Internal Unit Standards</i>													
US4247	-	Describe general characteristics of peoples in New Zealand	Internal	2						✓✓			
US10781	-	Produce a plan for own future directions	Internal	3				✓			✓		
US4252	-	Produce a personal targeted C.V.	Internal	2				✓		✓	✓		
US377	-	Demonstrate knowledge of diversity in the workplace	Internal	2				✓	✓✓	✓✓	✓		
US12349	-	Demonstrate knowledge of time management	Internal	3									
US3492	-	Write a short report	Internal	3				✓		✓✓	✓✓		
US4253	-	Demonstrate knowledge of job search skills	Internal	3				✓		✓	✓		
<i>Possible Credits Available</i>			18 Credits										
						<i>Total recommended ✓ credits</i>		13	<i>Total sector related ✓✓ credits</i>		2	5	10
								7			3		

CHEMISTRY (2CHE)

COURSE INFORMATION

Qualification and level:	NCEA Level 2
Course Prerequisites:	12 credits in NCEA Level 1 Science domain papers (and must include P1.1 investigation and S1.5 acids and bases, plus 10 credits in Mathematics .
	Students that do not meet the above prerequisites but who still wish to study Chemistry NCEA Level 2 will require an interview with the Head of Chemistry before they are signed into the course.
Fieldwork:	NIL
Approximate Course Costs:	\$20 Online Resources
Course Leads to:	NCEA Level 3/Year 13 Chemistry
Course Provider/Assessor:	Botany Downs Secondary College
Teacher in charge of subject:	Mrs Sharma
HOLA in charge of subject:	Mr Kumar

COURSE OUTLINE

Chemistry is the study of the nature and behaviour of substances. The study of chemistry helps everyone understand the modern world (e.g. paints, plastics, food additives, fuels, agriculture, etc.); it is also an important science for the future study of life/health sciences, or engineering.

This is a practically-based course intended to develop the skills and knowledge appropriate to the study of chemistry. Contexts that are relevant to students will be used throughout.

Level 2 Chemistry is essential to underpin Level 3 Chemistry. Students must obtain achievement in two of the three external papers and two of the three internal assessments to get into Level 3.

Both Level 2 and Level 3 Chemistry require strength in calculations (use of numbers and rearrangement of memorised formulae). Students require a good ability in written English as explanations and discussions of chemical concepts are essential.

STANDARDS

Standards for this course will be selected from those listed below and are at the discretion of the HOLA
 Level 2 Standards that contribute to Literacy and Numeracy are indicated by (L) = Literacy; (N) = Numeracy
 Level 2 & 3 Standards that contribute to UE literacy requirements are indicated by (R) = Reading; (W) = Writing

VOCATIONAL PATHWAYS

Vocational Pathway information helps with future career planning. Each Standard has been aligned to a potential Pathway, reflected by a tick in the relevant column of the table. "What is your pathway?" Please refer to page 5 in this book or pages 22 and 23 in the Level 1-3 Information Book for more information regarding Vocational Pathways.

STANDARDS						VOCATIONAL PATHWAYS					
Number	Subject Ref	Title	Int/Ext	Credits	CODES	Construction & Infrastructure	Manufacturing & Technology	Primary Industries	Service Industries	Social & Community Services	Creative Industries
<i>NCEA Internal Achievement Standards/Unit Standards</i>											
AS91161	Chemistry 2.1	Carry out quantitative analysis	Internal	4	N	✓	✓	✓		✓	✓
AS91162	Chemistry 2.2	Carry out procedures to identify ions present in solution	Internal	3		✓	✓	✓		✓	✓
AS91167	Chemistry 2.7	Demonstrate understanding of oxidation-reduction	Internal	3		✓	✓	✓		✓	✓
<i>NCEA External Achievement Standards</i>											
AS91164	Chemistry 2.4	Demonstrate understanding of bonding, structure and energy changes	External	5	L	✓	✓	✓		✓	✓
AS91165	Chemistry 2.5	Demonstrate understanding of the properties of selected organic compounds	External	4	L	✓	✓	✓	✓	✓	
AS91166	Chemistry 2.6	Demonstrate understanding of chemical reactivity	External	4	L	✓	✓	✓	✓	✓	✓
<i>Possible Credits Available</i>			23 Credits								
						<i>Total recommended ✓ credits</i>					
						23	23	23	8	23	19
						<i>Total sector related ✓✓ credits</i>					

CHEMISTRY - ALTERNATIVE (2CHA)

COURSE INFORMATION

Qualification and level:	NCEA Level 2
Course Prerequisites:	12 credits in NCEA Level 1 Science domain papers (Must include S1.5 acids and bases, plus a minimum of 8 credits in Mathematics .
	Students that do not meet the above prerequisites but who still wish to study Chemistry NCEA Level 2 will require an interview with the Head of Chemistry before they are signed into the course.
Fieldwork:	NIL
Approximate Course Costs:	\$20 Online Resources
Course Leads to:	NCEA Level 3/Year 13 Chemistry
Course Provider/Assessor:	Botany Downs Secondary College
Teacher in charge of subject:	Mrs Sharma
HOLA in charge of subject:	Mr Kumar

COURSE OUTLINE

Chemistry is the study of the nature and behaviour of substances. The study of chemistry helps everyone understand the modern world (e.g. paints, plastics, food additives, fuels, agriculture, etc.); it is also an important science for the future study of life/health sciences, or engineering.

This is a practically-based course intended to develop the skills and knowledge appropriate to the study of chemistry. Contexts that are relevant to students will be used throughout.

Level 2 Chemistry is essential to underpin Level 3 Chemistry. Students must obtain achievement in two of the three external papers and two of the three internal assessments to get into Level 3.

Both Level 2 and Level 3 Chemistry require strength in calculations (use of numbers and rearrangement of memorised formulae). Students require a good ability in written English as explanations and discussions of chemical concepts are essential.

STANDARDS

Standards for this course will be selected from those listed below and are at the discretion of the HOLA
 Level 2 Standards that contribute to Literacy and Numeracy are indicated by (L) = Literacy; (N) = Numeracy
 Level 2 & 3 Standards that contribute to UE literacy requirements are indicated by (R) = Reading; (W) = Writing

VOCATIONAL PATHWAYS

Vocational Pathway information helps with future career planning. Each Standard has been aligned to a potential Pathway, reflected by a tick in the relevant column of the table. "What is your pathway?" Please refer to page 5 in this book or pages 22 and 23 in the Level 1-3 Information Book for more information regarding Vocational Pathways.

STANDARDS						VOCATIONAL PATHWAYS					
Number	Subject Ref	Title	Int/Ext	Credits	CODES	Construction & Infrastructure	Manufacturing & Technology	Primary Industries	Service Industries	Social & Community Services	Creative Industries
<i>NCEA Internal Achievement Standards/Unit Standards</i>											
AS91161	Chemistry 2.1	Carry out quantitative analysis	Internal	4	N	✓	✓	✓		✓	✓
AS91162	Chemistry 2.2	Carry out procedures to identify ions present in solution	Internal	3		✓	✓	✓		✓	✓
AS91167	Chemistry 2.7	Demonstrate understanding of oxidation-reduction	Internal	3		✓	✓	✓		✓	✓
<i>NCEA External Achievement Standards</i>											
AS91164	Chemistry 2.4	Demonstrate understanding of bonding, structure and energy changes	External	5	L	✓	✓	✓		✓	✓
AS91165	Chemistry 2.5	Demonstrate understanding of the properties of selected organic compounds	External	4	L	✓	✓	✓	✓	✓	
AS91166	Chemistry 2.6	Demonstrate understanding of chemical reactivity	External	4	L	✓	✓	✓	✓	✓	✓
<i>Possible Credits Available</i>			23 Credits								
						23	23	23	8	23	19
						<i>Total recommended ✓ credits</i>					
						<i>Total sector related ✓✓ credits</i>					

CHINESE (2CHI)

COURSE INFORMATION

Qualification and level:	NCEA Level 2
Course Prerequisites:	Entry by application or interview
Fieldwork:	Nil
Approximate Course Costs:	Approximately \$30 for workbooks and language perfect
Course Leads to:	This course provides students with the skills and content knowledge to continue with Level 3 Chinese contributing credits to NCEA Level 3
Course Provider/Assessor:	Botany Down Secondary College
Teacher in charge of subject:	Mrs Kuang
HOLA in charge of subject:	

COURSE OUTLINE

This course encourages effective communication in listening and responding, speaking and presenting, interacting, reading/viewing and writing in Chinese.

Students can understand and produce complex language in a variety of text types in Chinese. They can use Chinese variably and effectively to express and justify their own ideas and opinions and support and challenge those of others. They are able to use and identify the linguistic and cultural forms that guide interpretation and enable them to respond critically to texts. By the end of Year 12, students will have presented for assessment in 24 credits of NCEA Level Two.

Topics studied may include:

- Living in New Zealand
- School and education
- Culture and Festivals
- Chinese ancient poems and modern literature
- Film study
- Study skills
- Career planning/pathways

Applications and more information can be obtained from Mrs Kuang.

STANDARDS

Standards for this course will be selected from those listed below and are at the discretion of the HOLA
 Level 2 Standards that contribute to Literacy and Numeracy are indicated by (L) = Literacy: (N) = Numeracy
 Level 2 & 3 Standards that contribute to UE literacy requirements are indicated by (R) = Reading: (W) = Writing

VOCATIONAL PATHWAYS

Vocational Pathway information helps with future career planning. Each Standard has been aligned to a potential Pathway, reflected by a tick in the relevant column of the table. "What is your pathway?" Please refer to page 5 in this book or pages 22 and 23 in the Level 1-3 Information Book for more information regarding Vocational Pathways.

STANDARDS						VOCATIONAL PATHWAYS					
Number	Subject Ref	Title	Int/Ext	Credits	CODES	Construction & Infrastructure	Manufacturing & Technology	Primary Industries	Service Industries	Social & Community Services	Creative Industries
<i>NCEA Internal Achievement Standards/Unit Standards</i>											
AS 91109	Chinese 2.3	Interact using spoken Chinese to share information and justify ideas and opinions in different situations	Internal	5					✓✓	✓	✓
AS91110	Chinese 2.2	Give a spoken presentation in Chinese that communicates information, ideas and opinions	Internal	4							
AS91112	Chinese 2.5	Write a variety of text types in Chinese to convey information, ideas, and opinions in genuine contexts	Internal	5					✓		✓
<i>NCEA External Achievement Standards</i>											
AS91108	Chinese 2.1	Demonstrate understanding of a variety of spoken Chinese texts on familiar matters	External	5					✓		✓
AS91111	Chinese 2.4	Demonstrate understanding of a variety of written and/or visual Chinese text(s) on familiar matters	External	5					✓		
<i>Possible Credits Available</i>				24 Credits							
						<i>Total recommended ✓ credits</i>					
						<i>Total sector related ✓✓ credits</i>					
						16 5 15					
						5					

CLASSICAL STUDIES (2CLS)

COURSE INFORMATION

Qualification and level:	NCEA Level 2
Course Prerequisites:	12 credits in one of NCEA Level 1 History or English Achievement Standards, (at least <u>one</u> of AS91005, AS90851, AS90052 or AS90053).
Fieldwork:	Nil
Approximate Course Costs:	Nil
Course Leads to:	NCEA Level 3 Classical Studies and Scholarship
Course Provider/Assessor:	Botany Downs Secondary College
Teacher in charge of subject:	Mr Mihajlov
HOLA in charge of subject:	Mr Andrew

COURSE OUTLINE

Classical Studies is the holistic study of the Greek and Roman civilisations. It covers philosophy, art, architecture, society, politics, drama, literature and history. Level 2 Classical Studies focuses on introducing the ancient world to students and developing the skills necessary to study ancient history. The study of ancient history involves looking at all aspects of a society in order to piece together what life would have been like, beliefs and values of the people of that time, and the major historical events of the period. Level 2 Classical Studies focuses on the 'Golden Age' of Greece - 5th Century BCE Athens. The course begins with an introductory Greek history topic. This is followed by the Socio-Political topic in which we learn about the life and society of Athens in the 5th Century BCE. The Greek Drama topic focuses on the playwright Sophocles and his two most famous plays Oedipus Rex and Antigone. The other topic that may be covered during the year is Art and Architecture of 5th Century BC Athens.

STANDARDS

Standards for this course will be selected from those listed below and are at the discretion of the HOLA
 Level 2 Standards that contribute to Literacy and Numeracy are indicated by (L) = Literacy; (N) = Numeracy
 Level 2 & 3 Standards that contribute to UE literacy requirements are indicated by (R) = Reading; (W) = Writing

VOCATIONAL PATHWAYS

Vocational Pathway information helps with future career planning. Each Standard has been aligned to a potential Pathway, reflected by a tick in the relevant column of the table. "What is your pathway?" Please refer to page 5 in this book or pages 22 and 23 in the Level 1-3 Information Book for more information regarding Vocational Pathways.

STANDARDS						VOCATIONAL PATHWAYS					
Number	Subject Ref	Title	Int/Ext	Credits	CODES	Construction & Infrastructure	Manufacturing & Technology	Primary Industries	Service Industries	Social & Community Services	Creative Industries
<i>NCEA Internal Achievement Standards/Unit Standards</i>											
AS91202	Classical Studies 2.3	Examine a significant event in the classical world	Internal	4	R						✓
AS91204	Classical Studies 2.5	Demonstrate understanding of the influence of aspects of the classical world on other cultures	Internal	6	R						✓
<i>NCEA External Achievement Standards</i>											
AS91200	Classical Studies 2.1	Examine ideas and values of the classical world	External	4	R/W						✓
AS91201	Classical Studies 2.2	Examine the significance of features of work(s) of art in the classical world	External	4	R/W				✓		✓✓
AS91203	Classical Studies 2.4	Demonstrate understanding of socio-political life in the classical world	External	6	R/W						✓
<i>Possible Credits Available</i>			24 Credits								
						<i>Total recommended ✓ credits</i>			4	20	
						<i>Total sector related ✓✓ credits</i>			4		

DANCE (2DAN)

COURSE INFORMATION

Qualification and level:	NCEA Level 2
Course Prerequisites:	Level 1 Dance, 8 credits in NCEA Level 1 English
Fieldwork:	\$40
Approximate Course Costs:	\$50 - Guest tutors
Course Leads to:	NCEA Level 3 Dance
Course Provider/Assessor:	Botany Downs Secondary College
Teacher in charge of subject:	Mrs Rakanui
HOLA in charge of subject:	Mrs Rakanui

COURSE OUTLINE

The Level 2 Dance course will focus on composition and performance. Dance is a subject which explores a range of dance techniques, Choreography and Dance theories. Dance at Level 2 is both physically demanding and mentally challenging. Students are required to dance and complete a logbook. The Level 2 Dance programme has a strong choreographic focus: students will have an opportunity to choreograph junior classes. Students will develop a range of dance techniques (such as Contemporary dance, Pacifica dance, NZ Dance, etc) from a variety of sources, as well as a broad range of choreographic tools for dance making. Students are required to rehearse as part of their on-going homework in this subject. Students will be required to view a minimum of two live dance performances.

Students will complete 18-22 of the internal credits available, and 4 external credits.

STANDARDS

Standards for this course will be selected from those listed below and are at the discretion of the HOLA
 Level 2 Standards that contribute to Literacy and Numeracy are indicated by (L) = Literacy; (N) = Numeracy
 Level 2 & 3 Standards that contribute to UE literacy requirements are indicated by (R) = Reading; (W) = Writing

VOCATIONAL PATHWAYS

Vocational Pathway information helps with future career planning. Each Standard has been aligned to a potential Pathway, reflected by a tick in the relevant column of the table. "What is your pathway?" Please refer to page 5 in this book or pages 22 and 23 in the Level 1-3 Information Book for more information regarding Vocational Pathways.

STANDARDS						VOCATIONAL PATHWAYS							
Number	Subject Ref	Title	Int/Ext	Credits	CODES	Infrastructure	Construction & Technology	Engineering & Manufacturing Industries	Primary Industries	Service Industries	Community Services	Social & Community	Creative Industries
<i>NCEA Internal Achievement Standards/Unit Standards</i>													
AS91205	Dance 2.1	Choreograph a group dance to communicate an intention	Internal	4									✓✓
AS91206	Dance 2.2	Choreograph a solo dance to communicate an intention	Internal	4									✓✓
AS91207	Dance 2.3	Perform an ethnic or social dance	Internal	4									✓✓
AS91208	Dance 2.4	Perform a theatre dance to communicate understanding of the dance	Internal	4									✓✓
AS91209	Dance 2.5	Perform a repertoire of dance	Internal	6									✓✓
<i>NCEA External Achievement Standards</i>													
AS91211	Dance 2.7	Provide an interpretation of a dance performance with supporting evidence	External	4	L								✓✓
			<i>Possible Credits Available</i>										
			22 Credits										
						<i>Total recommended ✓ credits</i>							
						<i>Total sector related ✓✓ credits</i>							
						26							

DESIGN AND VISUAL COMMUNICATION (2DVC)

COURSE INFORMATION

Qualification and level:	NCEA Level 2
Course Prerequisites:	At least 12 credits in NCEA Level 1 Design and Visual Communication or HOLA discretion
Fieldwork:	NIL
Approximate Course Costs:	\$30
Course Leads to:	NCEA Level 3 Graphics
Course Provider/Assessor:	Botany Downs Secondary College
Teacher in charge of subject:	Mr Achary
HOLA in charge of subject:	Mr Achary

COURSE OUTLINE

This course will build on the experiences of Level 1 Design and Visual Communication and will enable students to apply their acquired knowledge to a selection of challenging design briefs. These design opportunities will enable students to explore areas that better suit their interests and strengths. Students will choose from one of the following design areas: Spatial or Product Design. The units of work are planned to enable students to achieve in both the internal and external achievement standards through varied and realistic problem solving involving design, drawing, modelling, presenting, testing and evaluation.

It is important to note that this course is a prerequisite if students are intending to take DVC in Year 13 next year.

STANDARDS

Standards for this course will be selected from those listed below and are at the discretion of the HOLA
 Level 2 Standards that contribute to Literacy and Numeracy are indicated by (L) = Literacy; (N) = Numeracy
 Level 2 & 3 Standards that contribute to UE literacy requirements are indicated by (R) = Reading; (W) = Writing

VOCATIONAL PATHWAYS

Vocational Pathway information helps with future career planning. Each Standard has been aligned to a potential Pathway, reflected by a tick in the relevant column of the table. "What is your pathway?" Please refer to page 5 in this book or pages 22 and 23 in the Level 1-3 Information Book for more information regarding Vocational Pathways.

STANDARDS						VOCATIONAL PATHWAYS					
Number	Subject Ref	Title	Int/Ext	Credits	CODES	Construction & Infrastructure	Manufacturing & Technology	Primary Industries	Service Industries	Social & Community Services	Creative Industries
<i>NCEA Internal Achievement Standards/Unit Standards</i>											
AS 91341 AS91342	AS 2.34 or 2.35	Develop a spatial or Product design through graphics practice	Internal	6		✓✓	✓				✓✓
AS91343		Use visual communication techniques to compose a presentation of a design	Internal	4		✓✓	✓				✓✓
<i>NCEA External Achievement Standards</i>											
AS91337	AS2.30	Use visual communication techniques to generate design ideas	External	3		✓✓	✓	✓	✓		✓✓
AS91338	AS 2.31	Produce working drawings to communicate technical details of a design	External	4		✓✓	✓✓	✓			✓✓
AS91339	AS 2.32	Produce instrumental perspective projection drawings to communicate design ideas	External	3		✓✓	✓✓				✓✓
<i>Possible Credits Available</i>			20 Credits								
						Total recommended ✓ credits	13	7	3		
						Total sector related ✓✓ credits	20	7			

DIGITAL TECHNOLOGIES WITH INFORMATION SYSTEMS (2DIT)

COURSE INFORMATION

Qualification and level:	NCEA Level 2
Course Prerequisites:	10 credits in NCEA Level 1 DIT or See Head of DIT for accessing online courses to meet prerequisites.
Fieldwork:	Nil
Approximate Course Costs:	\$10 Online course, \$10 USB memory stick
Course Leads to:	Level 3 Digital Technologies
Course Provider/Assessor:	Botany Downs Secondary College
Teacher in charge of subject:	Mr Patchigalla
HOLA in charge of subject:	Mr Achary

COURSE OUTLINE

This course is designed to consolidate and develop advanced skills in Digital Technologies, Web and print, knowledge of design principles, and the technological process. Students will acquire a range of practical skills and demonstrate these using various multimedia and software applications as required to produce a solution for a project. Software used will include Photoshop, Illustrator, phpMyAdmin, Notepad++ or similar applications. The students will learn and implement advanced tools and techniques in HTML5/CSS3 for web development, PHP and MySQL for database development.

There will be a focus on digital media and information systems including web-design, and software integration using a database and develop understanding of information systems.

Please note students can only take a maximum of two subjects from 2DIT, 2DIP, and one of 2TEM/2TET/2TEF

STANDARDS

Standards for this course will be selected from those listed below and are at the discretion of the HOLA
 Level 2 Standards that contribute to Literacy and Numeracy are indicated by (L) = Literacy; (N) = Numeracy
 Level 2 & 3 Standards that contribute to UE literacy requirements are indicated by (R) = Reading; (W) = Writing

VOCATIONAL PATHWAYS

Vocational Pathway information helps with future career planning. Each Standard has been aligned to a potential Pathway, reflected by a tick in the relevant column of the table. "What is your pathway?" Please refer to page 5 in this book or pages 22 and 23 in the Level 1-3 Information Book for more information regarding Vocational Pathways.

STANDARDS						VOCATIONAL PATHWAYS							
Number	Subject Ref	Title	Int/Ext	Credits	CODES	Infrastructure	Construction & Technology	Manufacturing & Industries	Primary Industries	Service Industries	Community Services	Social & Community	Creative Industries
<i>NCEA Internal Achievement Standards/Unit Standards</i>													
AS91356	Digital Technologies	Develop a conceptual design for an outcome	Internal	6		✓	✓	✓					✓✓
AS91368	Digital Technologies	Implement advanced procedures to produce a specified digital information with dynamically linked data (Not available to student who also chooses 2DIP)	Internal	6			✓✓			✓			✓
AS91369	Digital Technologies	Demonstrate understanding of advanced concepts of digital media (only available to student who also chooses 2DIP)	Internal	4			✓✓			✓			✓✓
AS91370	Digital Technologies	Implement advanced procedures to produce a specified digital media outcome	Internal	4			✓✓			✓			✓✓
<i>NCEA External Achievement Standards</i>													
AS91367	Digital Technologies	Demonstrate understanding of advanced concepts of information systems used to managed shared information	External	3	L		✓✓	✓		✓			✓
<i>Possible Credits Available</i>			17-19 Credits										
						<i>Total recommended ✓ credits</i>		6	6	9	17		9
						<i>Total sector related ✓✓ credits</i>			17				14

DIGITAL TECHNOLOGIES with PROGRAMMING (2DIP)

COURSE INFORMATION

Qualification and level:	NCEA Level 2
Course Prerequisites:	10 credits in NCEA Level 1 Digital Technologies including the Programming standard (91076) or See Head of DIT for accessing online courses to meet prerequisites.
Fieldwork:	Nil
Approximate Course Costs:	\$10 Online course, \$10 USB memory stick
Course Leads to:	Continue toward NCEA level 3 Digital Technologies or programming
Course Provider/Assessor:	Botany Downs Secondary College
Teacher in charge of subject:	Mr Patchigalla
HOLA in charge of subject:	Mr Achary

COURSE OUTLINE

This course is a progression from Level 1 Digital Technologies. This is a challenging course designed for students particularly interested in software programming and computer science concepts and have an interest in software development as a career option or tertiary study. The topics that we will cover are program planning, development, database, and website design.

Software used will include Photoshop, phpMyAdmin, Notepad++ or similar applications, Python IDE. The students will learn and implement advanced tools and techniques in HTML5/CSS3 for web development, PHP and MySQL for database development, Python for implementing an advanced computer programme. They will also develop understanding of advanced computer science concepts including data representation, encoding and human computer interaction.

Please note students can only take a maximum of two subjects from 2DIT, 2DIP, or one of 2TEM/2TET/2TEF

STANDARDS

Standards for this course will be selected from those listed below and are at the discretion of the HOLA
 Level 2 Standards that contribute to Literacy and Numeracy are indicated by (L) = Literacy; (N) = Numeracy
 Level 2 & 3 Standards that contribute to UE literacy requirements are indicated by (R) = Reading; (W) = Writing

VOCATIONAL PATHWAYS

Vocational Pathway information helps with future career planning. Each Standard has been aligned to a potential Pathway, reflected by a tick in the relevant column of the table. "What is your pathway?" Please refer to page 5 in this book or pages 22 and 23 in the Level 1-3 Information Book for more information regarding Vocational Pathways.

STANDARDS						VOCATIONAL PATHWAYS							
Number	Subject Ref	Title	Int/Ext	Credits	CODES	Infrastructure & Construction	Technology & Manufacturing	Primary Industries	Service Industries	Community Services	Social & Community	Creative Industries	
<i>NCEA Internal Achievement Standards/Unit Standards</i>													
AS91368	Digital Technologies	Implement advanced procedures to produce a specified digital information with dynamically linked data	Internal	6			✓✓		✓			✓	
AS91372	Digital Technologies	Construct a plan for an advanced computer program for a specified task	Internal	3			✓✓					✓✓	
AS91373	Digital Technologies	Construct an advanced computer program for a specified task	Internal	3			✓✓					✓✓	
AS91378	Digital Technologies	Implement procedures for administering a local area network	Internal	4			✓✓					✓	
<i>NCEA External Achievement Standards</i>													
AS91371	Digital Technologies	Demonstrate understanding of advanced concepts from computer science	External	4	L		✓✓					✓✓	
<i>Possible Credits Available</i>			20 Credits										
						<i>Total recommended ✓ credits</i>		6		10			
						<i>Total sector related ✓✓ credits</i>		20		10			

DRAMA (2DRA)

COURSE INFORMATION

Qualification and level:	NCEA Level 2
Course Prerequisites:	14 credits in NCEA Level 1 Drama Achievement Standards or HOD approval
Fieldwork:	Students see at least two productions in preparation for the external exam – productions and costs to be advised
Approximate Course Costs:	Fieldwork expenses - Approx \$40
Course Leads to:	NCEA Level 3 and Scholarship Drama
Course Provider/Assessor:	Botany Downs Secondary College
Teacher in charge of subject:	Ms Hood
HOLA in charge of subject:	Ms Hood

COURSE OUTLINE

Drama: Exciting, interesting, practical and varied. Within drama you will not only study the craft of acting and theatre, you will also learn extremely valuable transferrable skills for example – collaboration, recall, empathy, analysis, evaluation, deconstruction of a given subject and construction of performance pieces. It is a fantastic qualification which helps you develop your confidence and communication skills and has advantages for college, university and future employment. Drama leads to University Entrance and will give you a grounding in skills that you can use in a number of curriculum areas, whilst supporting your career aspirations.

This course is a progression from Level 1 Drama, however we have had students be successful in Drama who have joined the course at Level 2 at the discretion of the Head of Drama. The course provides an opportunity to use and explore the elements, conventions, techniques and technologies of Drama, both in process and in performance work. You will rehearse and perform works in a range of dramatic forms. Class work consists mainly of group work, and it is important for you to work co-operatively. In Level 2 Drama you are required to become more independent and critical in your choices and analysis of Drama, both theoretically and practically. Taking Drama develops your ability to think creatively and apply this thinking in practical ways, find solutions to practical and technical problems and to present yourself with confidence. It encourages leadership skills and collaborative skills. You will find ample opportunities to challenge yourself in practical tasks and in your response to the work of theatre practitioners and professional performers. Please be aware that most Achievement Standards will be assessed during public evening performances. Line learning is a fundamental skill required for this course and this is a transferable skill across all your subjects in preparation for examinations. You will be expected to see at least two live professional theatre performances during the year. You will require black loose pants, black plain long sleeve top and black canvas shoes for this course.

STANDARDS

Standards for this course will be selected from those listed below and are at the discretion of the HOLA
 Level 2 Standards that contribute to Literacy and Numeracy are indicated by (L) = Literacy: (N) = Numeracy
 Level 2 & 3 Standards that contribute to UE literacy requirements are indicated by (R) = Reading: (W) = Writing

VOCATIONAL PATHWAYS

Vocational Pathway information helps with future career planning. Each Standard has been aligned to a potential Pathway, reflected by a tick in the relevant column of the table. "What is your pathway?" Please refer to page 5 in this book or pages 22 and 23 in the Level 1-3 Information Book for more information regarding Vocational Pathways.

STANDARDS						VOCATIONAL PATHWAYS					
Number	Subject Ref	Title	Int/Ext	Credits	CODES	Construction & Infrastructure	Manufacturing & Technology	Primary Industries	Service Industries	Social & Community Services	Creative Industries
<i>NCEA Internal Achievement Standards/Unit Standards</i>											
AS91213	Drama 2.1	Apply drama techniques in a scripted context	Internal	4	L						✓✓
AS91214	Drama 2.2	Devise and perform a drama to realise an intention	internal	5	L						✓✓
AS91216	Drama 2.4	Perform features of a complex drama/theatre form	Internal	4	L						✓✓
AS91217	Drama 2.5	Examine the work of a playwright	Internal	4	L						✓✓
AS91218	Drama 2.6	Perform a substantial acting role in a scripted production	Internal	5	L						✓✓
AS91220	Drama 2.8	Script a scene suitable for drama performance	Internal	4	L				✓		✓✓
AS91221	Drama 2.9	Direct a scene for drama performance	Internal	4	L				✓		✓
<i>NCEA External Achievement Standards</i>											
AS91215	Drama 2.3	Discuss a drama/theatre form or period with reference to text	External	4	L						✓✓
AS91219	Drama 2.7	Discuss drama elements, techniques, conventions and technologies within a performance	External	4	L						✓✓
<i>Possible Credits Available</i>			20 Credits								
<i>Total recommended ✓ credits</i>									8		4
<i>Total sector related ✓✓ credits</i>											34

EARLY CHILDHOOD EDUCATION (2ECE)

COURSE INFORMATION

Qualification and level:	NCEA Level 2
Course Prerequisites:	Interest in ECE / Early Childhood Education career pathways
Fieldwork:	Visit to early childhood centres
Approximate Course Costs:	Nil
Course Leads to:	Early Childhood Education Level 3
Course Provider/Assessor:	MIT
Teacher in charge of subject:	Mrs McGregor
HOLA in charge of subject:	Mr Saville

COURSE OUTLINE

This Level 2 Early Childhood Education course at Year 12 level introduces students to the education and care of young children in early childhood education settings. This course aims to prepare students to advance into higher level early childhood education and care. Ideally students should have some contact with a young child as the course requires observations and play activity experience with the child. An enthusiastic, positive and caring attitude, as well as good management and organisational skills are necessary components for success in this course.

If you are a Year 12 student wanting to do Early Childhood Education for the first time you should select 2ECE.

If you are a Year 12 student wanting to do Early Childhood Education for the second time (ie you completed 1ECE) you should select 3ECE. This is a Level 3 course . Please note these Level 3 credits count towards level 2 NCEA.

STANDARDS

Standards for this course will be selected from those listed below and are at the discretion of the HOLA
 Level 2 Standards that contribute to Literacy and Numeracy are indicated by (L) = Literacy; (N) = Numeracy
 Level 2 & 3 Standards that contribute to UE literacy requirements are indicated by (R) = Reading; (W) = Writing

VOCATIONAL PATHWAYS

Vocational Pathway information helps with future career planning. Each Standard has been aligned to a potential Pathway, reflected by a tick in the relevant column of the table. "What is your pathway?" Please refer to page 5 in this book or pages 22 and 23 in the Level 1-3 Information Book for more information regarding Vocational Pathways.

STANDARDS						VOCATIONAL PATHWAYS					
Number	Subject Ref	Title	Int/Ext	Credits	CODES	Construction & Infrastructure	Manufacturing & Technology	Primary Industries	Service Industries	Social & Community Services	Creative Industries
<i>NCEA Internal Achievement Standards/Unit Standards</i>											
US10024	ECE Level 2	Demonstrate knowledge of promoting the health and wellbeing of children in an ECE service	Internal	3						✓✓	
US26715	ECE Level 2	Describe professional image and demonstrate professional behaviours required of an early childhood educator	internal	3						✓✓	
US10020	ECE Level 2	Describe personal and environmental hygiene and safety practices in an ECE service	Internal	2						✓✓	
US26712	ECE Level 2	Demonstrate knowledge of, and apply, age-related nutrition needs in providing food for a child in an ECE service	Internal	4						✓✓	
US10021	ECE Level 2	Describe the basic needs of children in an ECE service	Internal	3						✓✓	
US10022	ECE Level 2	Demonstrate knowledge of attachment patterns and short-term separation in an ECE service	Internal	3						✓✓	
US10023	ECE Level 2	Describe transition situations in an ECE service	Internal	2						✓✓	
<i>Possible Credits Available</i>			No more than 20 Credits								
<i>Total recommended ✓ credits</i>											
<i>Total sector related ✓✓ credits</i>										20	

ECONOMICS (2ECO)

COURSE INFORMATION

Qualification and level:	NCEA Level 2
Course Prerequisites:	12 credits in NCEA Level 1 Economics (including one external) or at the discretion of Head of Commerce .
Fieldwork:	Trip to Rotorua, Gold mines
Approximate Course Costs:	To be confirmed
Course Leads to:	NCEA Level 3 Economics. Links to all Business Subjects
Course Provider/Assessor:	Botany Downs Secondary College
Teacher in charge of subject:	Mr Sharma
HOLA in charge of subject:	Mr Andrew

COURSE OUTLINE

The course focuses on the three key economic concerns; Inflation, Trade, Inequality and Economic Growth. These tricky issues, that governments must face, are investigated in a clear concise manner using economic models, economic theory and data. In addition, the policies that governments implement to deal with economic issues are also analysed. While developing economic literacy, the course develops an array of central learning skills. Students will become literate, numerate and be able to articulate an economic point of view. The internal assessment requires the investigation of an economic issue, where students will need to analyse and interpret economic data.

STANDARDS

Standards for this course will be selected from those listed below and are at the discretion of the HOLA
 Level 2 Standards that contribute to Literacy and Numeracy are indicated by (L) = Literacy; (N) = Numeracy
 Level 2 & 3 Standards that contribute to UE literacy requirements are indicated by (R) = Reading; (W) = Writing

VOCATIONAL PATHWAYS

Vocational Pathway information helps with future career planning. Each Standard has been aligned to a potential Pathway, reflected by a tick in the relevant column of the table. "What is your pathway?" Please refer to page 5 in this book or pages 22 and 23 in the Level 1-3 Information Book for more information regarding Vocational Pathways.

STANDARDS						VOCATIONAL PATHWAYS					
Number	Subject Ref	Title	Int/Ext	Credits	CODES	Construction & Infrastructure	Manufacturing & Technology	Primary Industries	Service Industries	Social & Community Services	Creative Industries
<i>NCEA Internal Achievement Standards/Unit Standards</i>											
AS91227	Economics 2.6	Analyse how Government Policy and contemporary issues interact	Internal	6	L				✓	✓	✓
AS91226	Economics 2.7	Analyse a contemporary economic issue of special interest using economic concepts and models	internal	4	L/N				✓		✓
<i>NCEA External Achievement Standards</i>											
AS91222	Economics 2.1	Analyse inflation using economic concepts and models	External	4	L				✓		✓
AS91223	Economics 2.2	Analyse international trade using economic concepts and models	External	4	L			✓	✓		✓
AS91224	Economics 2.3	Analyse Economic Growth using economic concepts and models	External	4	L				✓		✓
<i>Possible Credits Available</i>			22 Credits								
						<i>Total recommended ✓ credits</i>					
						<i>Total sector related ✓✓ credits</i>					
						4	22	6	22		

ELECTRONICS (2ELE)

COURSE INFORMATION

Qualification and level:	NCEA Level 2 and NCET level 2
Course Prerequisites:	12 credits in NCEA Level 1 Achievement Standards in both Science and Mathematics.
Fieldwork:	Workplace/tertiary provider visits as possible - to be confirmed
Approximate Course Costs:	Course Workbook - \$20; Certification costs: ECOA, \$10 or NCET \$15. Take-home Project Work \$50
Course Leads to:	NCET Level Three in Electronics Technology
Course Provider/Assessor:	Botany Downs Secondary College
Teacher in charge of subject:	Mr Jeet
HOLA in charge of subject:	Mr Kumar

COURSE OUTLINE

Electronics is the study and design of control, communication and computing devices that depend on electricity in circuits that contain different components. This course is for people who want to understand more about electronics, including how to construct electronic circuits. It introduces electrical and electronic components and systems. There is a balance between developing core skills in soldering and circuit construction and electrical and electronics theory (US18239 US18240 and US18241). Completing calculations is a core requirement of the course so students will need to have good mathematics skills. Designing and making useful electronic products is an essential part of this course (US18243) including making printed circuit boards (US18242).

To obtain the National Certificate in Electronics Technology (NCET) Level 2, a student needs to achieve all the Unit Standards below and at least 16 Level 2 credits from any combination of Computing, Mathematics, Chemistry, Physics, Science, or Statistics and Probability. Students that achieve Unit Standards 18240, 18242 and 18243 are eligible for the ETITO Certificate of Attainment (ECOA).

STANDARDS

Standards for this course will be selected from those listed below and are at the discretion of the HOLA
 Level 2 Standards that contribute to Literacy and Numeracy are indicated by (L) = Literacy; (N) = Numeracy
 Level 2 & 3 Standards that contribute to UE literacy requirements are indicated by (R) = Reading; (W) = Writing

VOCATIONAL PATHWAYS

Vocational Pathway information helps with future career planning. Each Standard has been aligned to a potential Pathway, reflected by a tick in the relevant column of the table. "What is your pathway?" Please refer to page 5 in this book or pages 22 and 23 in the Level 1-3 Information Book for more information regarding Vocational Pathways.

STANDARDS						VOCATIONAL PATHWAYS					
Number	Subject Ref	Title	Int/Ext	Credits	CODES	Construction & Infrastructure	Manufacturing & Technology	Primary Industries	Service Industries	Social & Community Services	Creative Industries
<i>NCEA Internal Achievement Standards/Unit Standards</i>											
US18239	-	Demonstrate knowledge of basic electric circuit concepts, calculations, and measurements	Internal	5			✓✓				✓
US18240	-	Demonstrate knowledge of basic electronic components	internal	5			✓✓				✓
US18241	-	Demonstrate knowledge of basic electronic systems	Internal	5			✓✓				✓
US18242	-	Construct simple printed circuits	Internal	3			✓✓				✓✓
US18243	-	Construct simple electronic products from supplied circuit schematics	Internal	6			✓✓				✓✓
<i>Possible Credits Available</i>				24 Credits							
						<i>Total recommended ✓ credits</i>					15
						<i>Total sector related ✓✓ credits</i>					9

FINANCIAL STUDIES (2FIN)

COURSE INFORMATION

Qualification and level:	NCEA Level 2
Course Prerequisites:	75 credits at level 1 - including 12 credits in mathematics or at the discretion of HOD Commerce.
Fieldwork:	Field trip venue and costs to be confirmed
Approximate Course Costs:	\$20 for online FLP learning resource
Course Leads to:	NCEA Level 3 Financial Studies
Course Provider/Assessor:	Botany Downs Secondary College
Teacher in charge of subject:	Mr Sharma
HOLA in charge of subject:	Mr Andrew

COURSE OUTLINE

Financial Literacy Program is a well-established teen relevant programme. The programme consists of nine modules, investigation, various topics from saving to credit and borrowing to taxation, banking and budgeting. The focus is on: Individual circumstances; Acceptance of personal responsibility; A life cycle approach to planning and goal setting; Financial decisions and consequences; Building up personal equity; Encouraging personal financial security.

It is not necessary to have studied Commerce subjects previously. For more information regarding this course and progression through to tertiary education, please see Mr Sharma.

STANDARDS

Standards for this course will be selected from those listed below and are at the discretion of the HOLA

Level 2 Standards that contribute to Literacy and Numeracy are indicated by (L) = Literacy; (N) = Numeracy

Level 2 & 3 Standards that contribute to UE literacy requirements are indicated by (R) = Reading; (W) = Writing

VOCATIONAL PATHWAYS

Vocational Pathway information helps with future career planning. Each Standard has been aligned to a potential Pathway, reflected by a tick in the relevant column of the table. "What is your pathway?" Please refer to page 5 in this book or pages 22 and 23 in the Level 1-3 Information Book for more information regarding Vocational Pathways.

STANDARDS						VOCATIONAL PATHWAYS					
Number	Subject Ref	Title	Int/Ext	Credits	CODES	Infrastructure & Construction	Technology & Manufacturing	Primary Industries	Service Industries	Social & Community Services	Creative Industries
<i>NCEA Internal Achievement Standards/Unit Standards</i>											
28091	-	Produce a balanced budget for a family for personal financial management	Internal	3							
28092	-	Demonstrate knowledge of income for personal financial management	Internal	3							
28093	-	Make an informed decision relating to personal income and evaluate its consequences	Internal	2							✓
28096	-	Demonstrate an understanding of Personal insurance options	Internal	3					✓✓		
28095	-	Demonstrate knowledge of banking products and services for personal financial management	Internal	3					✓✓		✓
28094		Set a personal Financial goal and plan its implementation	Internal	3							
28097	-	Set a complex Personal financial goal and plan its implementation	Internal	3					✓✓		
<i>Possible Credits Available</i>			20 Credits								
						<i>Total recommended ✓ credits</i>					
						<i>Total sector related ✓✓ credits</i>					
						5					
						9					

FOOD & HOSPITALITY (2FAH)

COURSE INFORMATION

Qualification and level:	Level 2
Course Prerequisites:	Successful completion of year 11 TEF or FAH or a minimum of 14 credits in NCEA Technology level 1
Fieldwork:	Nil
Approximate Course Costs:	\$120 (basic course ingredients to be supplied, students may also be asked to bring food items), Competition \$30 (optional)
Course Leads to:	Hospitality trade - Cookery and Food Beverage Service
Course Provider/Assessor:	Botany Downs Secondary College
Teacher in charge of subject:	Mrs Thomson
HOLA in charge of subject:	Mr Achary

COURSE OUTLINE

This course gives a general introduction into the areas of food safety and hygiene, cookery and restaurant service and includes several practical components. Students will be given the opportunity to examine areas of professional cookery as a career that could also lead to tertiary study. Students need to have a genuine interest in working with food and be highly organised in the management of their time and practical preparations. A commitment to food service outside normal class time will also be expected.

Please note students can not take both Food & Hospitality (2FAH) and Food Technology (2TEF).

STANDARDS

Standards for this course will be selected from those listed below and are at the discretion of the HOLA
 Level 2 Standards that contribute to Literacy and Numeracy are indicated by (L) = Literacy; (N) = Numeracy
 Level 2 & 3 Standards that contribute to UE literacy requirements are indicated by (R) = Reading; (W) = Writing

VOCATIONAL PATHWAYS

Vocational Pathway information helps with future career planning. Each Standard has been aligned to a potential Pathway, reflected by a tick in the relevant column of the table. "What is your pathway?" Please refer to page 5 in this book or pages 22 and 23 in the Level 1-3 Information Book for more information regarding Vocational Pathways.

STANDARDS						VOCATIONAL PATHWAYS						
Number	Subject Ref	Title	Int/Ext	Credits	CODES	Infrastructure & Construction	Technology	Manufacturing & Industries	Primary Industries	Service Industries	Social & Community Services	Creative Industries
<i>NCEA Internal Achievement Standards/Unit Standards</i>												
US167	Food Safety	Practice food safety methods in a food business	Internal	4						✓✓		
US13285	Cookery	Handle and maintain knives in a commercial kitchen	Internal	2						✓✓		
US13276	Cookery	Cook food items by grilling	Internal	2						✓✓		
US13283	Cookery	Prepare salads in a commercial kitchen	Internal	2						✓✓		
US13281	Food & Bev	Prepare and present basic sandwiches for service	Internal	2						✓✓		
US14436	Food & Bev	Provide table service in a commercial hospitality environment	Internal	4						✓✓		
US 14425	Food & Bev	Prepare and serve hot and cold non-alcoholic drinks	Internal	2						✓✓		
<i>Possible Credits Available</i>				18 Credits								
						<i>Total recommended ✓ credits</i>						
						<i>Total sector related ✓✓ credits</i>						
						16						

FOOD TECHNOLOGY (2TEF)

COURSE INFORMATION

Qualification and level:	NCEA Level 2
Course Prerequisites:	A minimum of 14 credits in NCEA Technology or HOLA approval.
Fieldwork:	As may be required—travel costs not included
Approximate Course Costs:	\$120 (basic course ingredients to be supplied students may also be asked to bring food items); Competition \$30 (optional)
Course Leads to:	NCEA Level 3 Technology
Course Provider/Assessor:	Botany Downs Secondary College
Teacher in charge of subject:	Mrs Thomson
HOLA in charge of subject:	Mr Achary

COURSE OUTLINE

This course follows on from NCEA Level 1 Food Technology and is based on the Technology Curriculum. It is assessed against four Technology Achievement standards. It provides the opportunity for students to gain 18 credits at Level 2. There is no examination; however three of the Achievement Standards will be assessed internally and the other one will be assessed through external marking. Students will use a technological approach to develop innovative and creative problem solving skills. Practical skills in a wide range of materials are encouraged along with the learning of techniques and processes.

It is important to note that this course is a prerequisite if students are intending to take Food Technology in Year 13 next year. Please note students can not take both Food & Hospitality (2FAH) and Food Technology (2TEF). Please note students can choose only one from of the following Technology options: 2TEM, 2TET, 2TEF.

STANDARDS

Standards for this course will be selected from those listed below and are at the discretion of the HOLA
 Level 2 Standards that contribute to Literacy and Numeracy are indicated by (L) = Literacy; (N) = Numeracy
 Level 2 & 3 Standards that contribute to UE literacy requirements are indicated by (R) = Reading; (W) = Writing

VOCATIONAL PATHWAYS

Vocational Pathway information helps with future career planning. Each Standard has been aligned to a potential Pathway, reflected by a tick in the relevant column of the table. "What is your pathway?" Please refer to page 5 in this book or pages 22 and 23 in the Level 1-3 Information Book for more information regarding Vocational Pathways.

STANDARDS						VOCATIONAL PATHWAYS						
Number	Subject Ref	Title	Int/Ext	Credits	CODES	Construction & Infrastructure	Manufacturing & Technology	Primary Industries	Service Industries	Social & Community Services	Creative Industries	
<i>NCEA Internal Achievement Standards/Unit Standards</i>												
AS91354	Technology 2.1	Undertake brief development to address an issue	Internal	4		✓	✓	✓			✓✓	
AS91357	Technology 2.4	Develop effective development to make and trial a prototype	Internal	6		✓	✓✓	✓			✓✓	
AS91352	Technology 2.61	Implement advanced procedures to process a specified product	Internal	4	L		✓✓	✓	✓			
<i>NCEA External Achievement Standards</i>												
AS91358	Technology 2.5	Demonstrate understanding of how technological modelling supports risk management	External	4		✓	✓					
<i>Possible Credits Available</i>			18 Credits									
						<i>Total recommended ✓ credits</i>						
						14	8	14	4			
						<i>Total sector related ✓✓ credits</i>						
						10						10

FRENCH (2FRE)

COURSE INFORMATION

Qualification and level:	NCEA Level 2
Course Prerequisites:	Student must sit all standards and obtain at least 10 credits in NCEA Level 1 French including AS90881 (Reading). An interview might be required at the discretion of the TIC.
Fieldwork:	Possible NZAFT writing and speaking competitions Restaurant outing.
Approximate Course Costs:	Course costs \$25 including the yearly subscription to Language Perfect website
Course Leads to:	NCEA Level 3 French
Course Provider/Assessor:	Botany Downs Secondary College
Teacher in charge of subject:	Mrs Killip
HOLA in charge of subject:	Ms Lodge

COURSE OUTLINE

"To learn a language is to have one more window from which to look at the world." (Chinese proverb)

This course builds students' confidence to express and exchange ideas to establish real communication in French. Students will gain the skills to express opinions, to present facts and arguments on a range of topics talking about them and their place today's world, such as health, relationships, trends, cinema, fashion, French-speaking countries.

STANDARDS

Standards for this course will be selected from those listed below and are at the discretion of the HOLA
 Level 2 Standards that contribute to Literacy and Numeracy are indicated by (L) = Literacy; (N) = Numeracy
 Level 2 & 3 Standards that contribute to UE literacy requirements are indicated by (R) = Reading; (W) = Writing

VOCATIONAL PATHWAYS

Vocational Pathway information helps with future career planning. Each Standard has been aligned to a potential Pathway, reflected by a tick in the relevant column of the table. "What is your pathway?" Please refer to page 5 in this book or pages 22 and 23 in the Level 1-3 Information Book for more information regarding Vocational Pathways.

STANDARDS						VOCATIONAL PATHWAYS						
Number	Subject Ref	Title	Int/Ext	Credits	CODES	Construction & Infrastructure	Manufacturing & Technology	Primary Industries	Service Industries	Social & Community Services	Creative Industries	
<i>NCEA Internal Achievement Standards/Unit Standards</i>												
AS91120	French 2.2	Give a spoken presentation in French that communicates information, ideas and opinions	Internal	4								
AS91122	French 2.5	Write a variety of text types in French for genuine contexts	Internal	5					✓		✓	
<i>NCEA External Achievement Standards</i>												
AS91118	French 2.1	Demonstrate understanding of a variety of spoken French texts on familiar matters	External	5					✓		✓	
AS91121	French 2.4	Demonstrate understanding of a variety of written/visual French text(s) on familiar matters	External	5					✓			
<i>Possible Credits Available</i>			19 Credits									
						<i>Total recommended ✓ credits</i>			15			10
						<i>Total sector related ✓✓ credits</i>						

GEOGRAPHY (2GEO)

COURSE INFORMATION

Qualification and level:	NCEA Level 2
Course Prerequisites:	14 credits in NCEA Level 1 Geography or English (Achievement Standards) or History
Fieldwork:	Fieldtrips will be a component of this course.
Approximate Course Costs:	Geography skills book \$29. Fieldwork expenses: \$50 estimated costs
Course Leads to:	NCEA Level 3 Geography and Scholarship
Course Provider/Assessor:	Botany Downs Secondary College
Teacher in charge of subject:	Miss Brodie
HOLA in charge of subject:	Mr Andrew

COURSE OUTLINE

Geography examines contemporary landscapes, issues and patterns. It encourages students to understand their world and the space around them: how it was and is being formed and how people interact with their environment. To do this we use a wide range of resources and skills including maps, statistics, GIS, photographs, team work, field work, data presentation and report writing.

The Level 2 Geography course will include investigations into the reasons for disparities in development between different countries; the urban environment we live in and a study of a major overseas natural landscape. Field work will be undertaken to support class work.

The achievement standards that will be offered for assessment will be *selected* from those listed below and will offer students a total of between 18 and 21 credits. Not all achievement standards listed will be offered.

STANDARDS

Standards for this course will be selected from those listed below and are at the discretion of the HOLA
 Level 2 Standards that contribute to Literacy and Numeracy are indicated by (L) = Literacy; (N) = Numeracy
 Level 2 Standards that contribute to UE literacy requirements are indicated by (R) = Reading; (W) = Writing

VOCATIONAL PATHWAYS

Vocational Pathway information helps with future career planning. Each Standard has been aligned to a potential Pathway, reflected by a tick in the relevant column of the table. "What is your pathway?" Please refer to page 5 in this book or pages 22 and 23 in the Level 1-3 Information Book for more information regarding Vocational Pathways.

STANDARDS						VOCATIONAL PATHWAYS					
Number	Subject Ref	Title	Int/Ext	Credits	CODES	Construction & Infrastructure	Manufacturing & Technology	Primary Industries	Service Industries	Social & Community Services	Creative Industries
<i>NCEA Internal Achievement Standards/Unit Standards</i>											
AS91241	Geography 2.2	Demonstrate geographic understanding of an urban pattern	Internal	3	L	✓			✓✓		
AS91244	Geography 2.5	Conduct geographic research with guidance	Internal	5	L/N				✓		✓
AS91245	Geography 2.6	Explain aspects of a contemporary geographic issue	Internal	3	L				✓	✓	✓
AS91246	Geography 2.7	Explain aspects of a geographic topic at a global scale	Internal	3	L			✓	✓		
AS91247	Geography 2.8	Apply spatial analysis, with guidance, to solve a geographic problem	Internal	3	L/N			✓	✓		
<i>NCEA External Achievement Standards</i>											
AS91240	Geography 2.1	Demonstrate geographic understanding of a large natural environment	External	4	L			✓	✓✓		
AS91242	Geography 2.3	Demonstrate geographic understanding of differences in development	External	4	L				✓	✓	
AS91243	Geography 2.4	Apply concepts and geographic skills to demonstrate understanding of a given environment	External	4	L	✓		✓	✓		✓
<i>Possible Credits Available</i>			29 Credits								
<i>Total recommended ✓ credits</i>						7	11	19	7	12	
<i>Total sector related ✓✓ credits</i>						7	11	7	7	12	

HEALTH EDUCATION (2HED)

COURSE INFORMATION

Qualification and level:	NCEA Level 2
Course Prerequisites:	11 credits in NCEA Level 1 Health Education or HOLA approval (you will need to have proven ability in English)
Fieldwork:	Nil
Approximate Course Costs:	Nil
Course Leads to:	NCEA Level 3 Health Education Career Pathways in the Health Sector
Course Provider/Assessor:	Botany Downs Secondary College
Teacher in charge of subject:	Mrs Leidh
HOLA in charge of subject:	Mr Saville

COURSE OUTLINE

Level 2 Health Education builds on the knowledge that students have gained in Level 1 Health Education, focussing on health issues relevant to adolescent well-being. Students begin to further develop their ability to think critically about situations that impact the well-being of individuals, other people, relationships, and whole communities.

Students will engage in learning related to the topics of mental health and resiliency, gender and sexuality, and other relevant adolescent health issues. A major topic is based around critical action where the students work together to develop, implement and evaluate a plan of action to enhance the well-being of students in the school or local community. Students will engage in a variety of learning activities to develop their understanding of key ideas and concepts, including interactive group work, class and group-based discussions, research and investigations, value continuums, and individual reading and writing tasks.

The knowledge and skills developed through the Level 2 Health Education course will strengthen students understanding of the underlying health concepts, and enhance their Health Education literacy skills, including writing and research skills and their ability extract information from resource material. The Level 2 Health Education course also provides a pathway for further study at NCEA Level 3 Health Education or tertiary study related to social and health sciences.

The course will be co-constructed with the students at the beginning of the year using a selection of the standards below.

STANDARDS

Standards for this course will be selected from those listed below and are at the discretion of the HOLA
 Level 2 Standards that contribute to Literacy and Numeracy are indicated by (L) = Literacy; (N) = Numeracy
 Level 2 & 3 Standards that contribute to UE literacy requirements are indicated by (R) = Reading; (W) = Writing

VOCATIONAL PATHWAYS

Vocational Pathway information helps with future career planning. Each Standard has been aligned to a potential Pathway, reflected by a tick in the relevant column of the table. "What is your pathway?" Please refer to page 5 in this book or pages 22 and 23 in the Level 1-3 Information Book for more information regarding Vocational Pathways.

STANDARDS						VOCATIONAL PATHWAYS					
Number	Subject Ref	Title	Int/Ext	Credits	CODES	Construction & Infrastructure	Manufacturing & Technology	Primary Industries	Service Industries	Social & Community Services	Creative Industries
<i>NCEA Internal Achievement Standards/Unit Standards</i>											
AS91237	Health 2.3	Take action to enhance an aspect of people's well-being within the school or wider community	Internal	5	L				✓	✓✓	
AS91239	Health 2.5	Analyse issues related to sexuality and gender to develop strategies for addressing the issues	Internal	5	L			✓		✓✓	
AS91236	Health 2.2	Evaluate factors that influence people's ability to manage change	Internal	5	L			✓	✓	✓✓	
<i>NCEA External Achievement Standards</i>											
AS91235	Health 2.1	Analyse an adolescent health issue	External	5	L			✓	✓	✓	
AS91238	Health 2.4	Analyse an interpersonal issue(s) that place personal safety at risk	External	4	L			✓	✓	✓✓	
<i>Possible Credits Available</i>			19-24 Credits								
						<i>Total recommended ✓ credits</i>					
						<i>Total sector related ✓✓ credits</i>					
						19 19 5 19					

HISTORY (2HIS)

COURSE INFORMATION

Qualification and level:	NCEA Level 2
Course Prerequisites:	12 credits in one of NCEA Level One History, or Geography or English Achievement Standards, (at least <u>one</u> of AS91005, AS90851, AS90052 or AS90053).
Fieldwork:	
Approximate Course Costs:	
Course Leads to:	NCEA Level 3 History
Course Provider/Assessor:	Botany Downs Secondary College
Teacher in charge of subject:	Miss Douglas
HOLA in charge of subject:	Mr Andrew

COURSE OUTLINE

In Level 2 History the student is introduced to some major factors that have shaped today's world: nationalism, international relations, the search for security, government and political change. At this level students explore issues at greater depth and with more historical insight than during the previous year. Their investigations will often take them further in time – to the nineteenth century and in place to the Pacific, Asia and Europe. In Level 2 History, students will discover that while the past cannot be changed, the way it is viewed can and does change in the light of new evidence, new concerns in society and differing perspectives. History teaches students the skills of essay writing, interpreting cartoons, graphs, debating issues and learning research skills. These skills are helpful for tertiary education and for future careers in many fields eg, law, medicine, journalism and marketing. Themes will be the following: Nazi Germany and /or The Holocaust, and New Zealand Search for Security (Vietnam).

The achievement standards that will be offered for assessment will be *selected* from those listed below (not all are offered) and will provide students with a total of 18 credits.

STANDARDS

Standards for this course will be selected from those listed below and are at the discretion of the HOLA
 Level 2 Standards that contribute to Literacy and Numeracy are indicated by (L) = Literacy: (N) = Numeracy
 Level 2 & 3 Standards that contribute to UE literacy requirements are indicated by (R) = Reading: (W) = Writing

VOCATIONAL PATHWAYS

Vocational Pathway information helps with future career planning. Each Standard has been aligned to a potential Pathway, reflected by a tick in the relevant column of the table. "What is your pathway?" Please refer to page 5 in this book or pages 22 and 23 in the Level 1-3 Information Book for more information regarding Vocational Pathways.

STANDARDS						VOCATIONAL PATHWAYS					
Number	Subject Ref	Title	Int/Ext	Credits	CODES	Construction & Infrastructure	Manufacturing & Technology	Primary Industries	Service Industries	Social & Community Services	Creative Industries
<i>NCEA Internal Achievement Standards/Unit Standards</i>											
AS91229	History 2.1	Carry out a planned inquiry of an historical event, or place, of significant to New Zealanders	Internal	4	R				✓		✓
AS91232	History 2.4	Interpret different perspectives of people in an historical event of significance to New Zealanders	Internal	5	R						✓
<i>NCEA External Achievement Standards</i>											
AS91231	History 2.3	Examine sources of an historical event of significance to New Zealanders	External	4	R/W						✓
AS91233	History 2.5	Examine causes and consequences of a significant historical event	External	5	R/W						✓
AS91234	History 2.6	Examine how a significant historical event affected New Zealand society	External	5	R/W						✓
<i>Possible Credits Available</i>			18 Credits								
						<i>Total recommended ✓ credits</i>					
									4		23
						<i>Total sector related ✓✓ credits</i>					
										4	

JAPANESE (2JAP)

COURSE INFORMATION

Qualification and level:	NCEA Level 2
Course Prerequisites:	10 credits in NCEA Level 1 Japanese including standard 90896 (Reading)
Fieldwork:	Possible competitions: AUT Speech Competition, Trip to a Japanese restaurant (\$35)
Approximate Course Costs:	Course Costs- \$25.00 including subscription to Language Perfect website; Course book - \$35
Course Leads to:	NCEA Level 3 Japanese
Course Provider/Assessor:	Botany Downs Secondary College
Teacher in charge of subject:	Ms Lodge
HOLA in charge of subject:	Ms Lodge

COURSE OUTLINE

If you know only one language, you live only once. (Czech proverb)

This course builds students' confidence to express and exchange ideas to establish real communication in Japanese. Students will gain the skills to express opinions, to present facts and arguments on a range of topics such as school life, relationships, daily routine, shopping and eating out.

STANDARDS

Standards for this course will be selected from those listed below and are at the discretion of the HOLA
 Level 2 Standards that contribute to Literacy and Numeracy are indicated by (L) = Literacy; (N) = Numeracy
 Level 2 & 3 Standards that contribute to UE literacy requirements are indicated by (R) = Reading; (W) = Writing

VOCATIONAL PATHWAYS

Vocational Pathway information helps with future career planning. Each Standard has been aligned to a potential Pathway, reflected by a tick in the relevant column of the table. "What is your pathway?" Please refer to page 5 in this book or pages 22 and 23 in the Level 1-3 Information Book for more information regarding Vocational Pathways.

STANDARDS						VOCATIONAL PATHWAYS					
Number	Subject Ref	Title	Int/Ext	Credits	CODES	Construction & Infrastructure	Manufacturing & Technology	Primary Industries	Service Industries	Social & Community Services	Creative Industries
<i>NCEA Internal Achievement Standards/Unit Standards</i>											
AS91135	Japanese 2.2	Interact using spoken Japanese to share and justify information, ideas and opinions in different situations	Internal	4							
AS91137	Japanese 2.5	Write a variety of text types in Japanese for genuine contexts	Internal	5					✓		✓
<i>NCEA External Achievement Standards</i>											
AS91133	Japanese 2.1	Demonstrate understanding of a variety of spoken Japanese texts on familiar matters	External	5					✓		✓
AS91136	Japanese 2.4	Demonstrate understanding of a variety of written/visual Japanese text(s) on familiar matters	External	5					✓		
<i>Possible Credits Available</i>				19 Credits							
						<i>Total recommended ✓ credits</i>		15		10	
						<i>Total sector related ✓✓ credits</i>					

TE REO MAORI (2MAO)

COURSE INFORMATION

Qualification and level:	NCEA Level 2
Course Prerequisites:	12 credits in NCEA Level 1 Maori
Fieldwork:	N/A
Approximate Course Costs:	N/A
Course Leads to:	NCEA Level 3 Maori
Course Provider/Assessor:	Botany Downs Secondary College
Teacher in charge of subject:	Ms Lodge
HOLA in charge of subject:	Ms Lodge

COURSE OUTLINE

Achieving personal independence in te reo Māori
 By the end of level 7, students can take part in general conversation with speakers of te reo Māori, understand most of what is said, and contribute relevant comments. They can explain and discuss many of their own ideas and opinions and may use te reo Māori creatively. They can read a variety of authentic te reo Māori materials and write expressively for a range of purposes. Students use a range of strategies to help them learn te reo Māori effectively, and they demonstrate a high level of fluency for a learner of te reo Māori as a second language. The NCEA Level 2 course is the building block for NCEA Level 3 and helping students develop further independence in te reo Māori.

The usual mode of provisioning the Te Reo courses at each level is through Te Kura (The New Zealand Correspondence School) with the support of a Maori language specialist in the College.

STANDARDS

Standards for this course will be selected from those listed below and are at the discretion of the HOLA
 Level 2 Standards that contribute to Literacy and Numeracy are indicated by (L) = Literacy; (N) = Numeracy
 Level 2 & 3 Standards that contribute to UE literacy requirements are indicated by (R) = Reading; (W) = Writing

VOCATIONAL PATHWAYS

Vocational Pathway information helps with future career planning. Each Standard has been aligned to a potential Pathway, reflected by a tick in the relevant column of the table. "What is your pathway?" Please refer to page 5 in this book or pages 22 and 23 in the Level 1-3 Information Book for more information regarding Vocational Pathways.

STANDARDS						VOCATIONAL PATHWAYS					
Number	Subject Ref	Title	Int/Ext	Credits	CODES	Construction & Infrastructure	Manufacturing & Technology	Primary Industries	Service Industries	Social & Community Services	Creative Industries
<i>NCEA Internal Achievement Standards/Unit Standards</i>											
AS91284	Te Reo Maori 2.1	Whakarongo kia mohio ki te reo o te ao torotoro	Internal	4				✓	✓	✓	✓
AS91285	Te Reo Maori 2.2	Korero kia whakamahi i te reo o te ao torotoro	Internal	6				✓	✓✓	✓	✓
AS91288	Te Reo Maori 2.5	Waihanga tuhinga auaha i te reo o te ao torotoro	Internal	6				✓	✓✓	✓	✓
<i>NCEA External Achievement Standards</i>											
AS91286	Te Reo Maori 2.3	Panui kia mohio ki te reo o te ao torotoro	External	6				✓	✓	✓	✓
AS91287	Te Reo Maori 2.4	Tuhi i te reo o te ao torotoro	External	6				✓	✓	✓	✓
				<i>Possible Credits Available</i>							
				28 Credits							
						<i>Total recommended ✓ credits</i>		28		16	
						<i>Total sector related ✓✓ credits</i>		12		28	

MATHEMATICS & STATISTICS (2MAT)

COURSE INFORMATION

Qualification and level:	NCEA Level 2
Course Prerequisites:	Achieved in all NCEA Level 1 Mathematics and Statistics External achievement standards ,AS1.10 , AS1.13 and Algebraic skills test which will be sat during the school examinations in term 3.
Fieldwork:	Nil
Approximate Course Costs:	Workbook– EAS 2.7, EAS 2.12 approx. \$15, FX9750GII Casio Graphic calculator is compulsory -approximately \$120 .
Course Leads to:	NCEA Level 3 Mathematics with Calculus Alternative, NCEA Level 3 Statistics and Probability courses and NCEA Level 3 Mathematics
Course Provider/Assessor:	Botany Downs Secondary College
Teacher in charge of subject:	Ms Yu
HOLA in charge of subject:	Ms Bennet

COURSE OUTLINE

This course builds on previous years and establishes the basis for tertiary study in Mathematics and Statistics. This course provides students with the opportunity to gain up to 20 Level 2 Mathematics and Statistics credits. Some content in Algebra will be taught and assessed in the form of a topic test and the result for this test will be used as one of the pre-requisites for entering into a level 3 Calculus course.

STANDARDS

Standards for this course will be selected from those listed below and are at the discretion of the HOLA
 Level 2 Standards that contribute to Literacy and Numeracy are indicated by (L) = Literacy; (N) = Numeracy
 Level 2 & 3 Standards that contribute to UE literacy requirements are indicated by (R) = Reading; (W) = Writing

VOCATIONAL PATHWAYS

Vocational Pathway information helps with future career planning. Each Standard has been aligned to a potential Pathway, reflected by a tick in the relevant column of the table. "What is your pathway?" Please refer to page 5 in this book or pages 22 and 23 in the Level 1-3 Information Book for more information regarding Vocational Pathways.

STANDARDS						VOCATIONAL PATHWAYS					
Number	Subject Ref	Title	Int/Ext	Credits	CODES	Construction & Infrastructure	Manufacturing & Technology	Primary Industries	Service Industries	Social & Community Services	Creative Industries
<i>NCEA Internal Achievement Standards/Unit Standards</i>											
AS91259	Mathematics 2.4	Apply trigonometric relationships in solving problems	Internal	3	N	✓	✓				✓
AS91264	Mathematics 2.9	Use statistical methods to make an inference	Internal	4	L/N			✓	✓	✓	✓
AS91257	Mathematics 2.2	Apply graphical methods in solving problems	Internal	4	N	✓	✓	✓	✓		✓
<i>NCEA External Achievement Standards</i>											
AS91261	Mathematics 2.6	Apply algebraic methods in solving problems	External	4	N	✓	✓	✓			✓
AS91262	Mathematics 2.7	Apply calculus methods in solving problems	External	5	N	✓	✓	✓			✓
AS91267	Mathematics 2.12	Apply probability methods in solving problems	External	4	N			✓	✓	✓	✓
<i>Possible Credits Available</i>			24 Credits								
						<i>Total recommended ✓ credits</i>					
						16	16	21	12	8	24
						<i>Total sector related ✓✓ credits</i>					

MATHEMATICS & STATISTICS - ALTERNATIVE (2MAA)

COURSE INFORMATION

Qualification and level:	NCEA Level 2
Course Prerequisites:	Must have achieved in AS91035, AS91038 and at least one from AS91029, AS91027, AS91028, AS91031 Discretion of the Head of Mathematics
Fieldwork:	Nil
Approximate Course Costs:	Workbooks (2) \$12. Casio calculator (FX-9750GII) is compulsory \$90 to \$120
Course Leads to:	Many careers state that they need knowledge of Mathematics and statistical skills in their job specification. This course may lead to Level 3 Statistics and Probability Alternative (3SPA) or Level 3 Mathematics (3MAT)
Course Provider/Assessor:	Botany Downs Secondary College
Teacher in charge of subject:	Mr Rambhai
HOLA in charge of subject:	Ms Bennet

COURSE OUTLINE

This course is designed for students who find Mathematics and Statistics challenging and need more support in gaining Level 2 Mathematics and Statistics credits. The teaching and learning programme is designed such that students' are able to maximise their success. The 2MAA course also provides a significant number of credits towards each of the vocational pathways.

Recommendation: Students who are taking subjects that are heavy in field trips should not choose this subject.

STANDARDS

Standards for this course will be selected from those listed below and are at the discretion of the HOLA
Level 2 Standards that contribute to Literacy and Numeracy are indicated by (L) = Literacy; (N) = Numeracy
Level 2 & 3 Standards that contribute to UE literacy requirements are indicated by (R) = Reading; (W) = Writing

VOCATIONAL PATHWAYS

Vocational Pathway information helps with future career planning. Each Standard has been aligned to a potential Pathway, reflected by a tick in the relevant column of the table. "What is your pathway?" Please refer to page 5 in this book or pages 22 and 23 in the Level 1-3 Information Book for more information regarding Vocational Pathways.

STANDARDS						VOCATIONAL PATHWAYS					
Number	Subject Ref	Title	Int/Ext	Credits	CODES	Construction & Infrastructure	Manufacturing & Technology	Primary Industries	Service Industries	Social & Community Services	Creative Industries
<i>NCEA Internal Achievement Standards/Unit Standards</i>											
AS91264	Mathematics 2.9	Use statistical methods to make an inference	Internal	4	L/N			✓	✓	✓	✓
AS91269	Mathematics 2.14	Apply systems of equations in solving problems	Internal	2	N	✓	✓				✓
AS91259	Mathematics 2.4	Apply trigonometric relationships in solving problems	Internal	3	N	✓	✓				✓
AS91265	Mathematics 2.10	Conduct an experiment to investigate a situation using statistical methods	Internal	3	L/N	✓	✓	✓	✓	✓	✓
AS91268	Mathematics 2.13	Investigate a situation involving elements of chance using a simulation	Internal	2	N			✓	✓	✓	✓
AS91260	Mathematics 2.5	Apply network methods in solving problems	Internal	2	N	✓	✓	✓	✓	✓	✓
<i>NCEA External Achievement Standards</i>											
AS91267	Mathematics 2.12	Apply probability methods in solving problems	External	4	N			✓	✓	✓	✓
<i>Possible Credits Available</i>			20 Credits								
<i>Total recommended ✓ credits</i>						10	10	11	9	11	16
<i>Total sector related ✓✓ credits</i>											

MATHEMATICS & STATISTICS - EXTENDED (2MAE)

COURSE INFORMATION

Qualification and level:	NCEA Level 2
Course Prerequisites:	Merit or higher in all NCEA Level 1 Mathematics and Statistics External achievement standards, AS1.10, AS1.13 and Algebraic skills test which will be sat during the school examinations in term 3.
Fieldwork:	Nil
Approximate Course Costs:	Workbook– EAS workbook approx. \$20, FX9750GII Casio Graphic calculator is compulsory - approximately \$120
Course Leads to:	This course will lead to NCEA Level 3 Mathematics with Calculus and Statistics and Probability courses. It also helps to provide the Mathematical skills needed in other subjects at Level 3. Many careers state that they need this course in their job specification.
Course Provider/Assessor:	Botany Downs Secondary College
Teacher in charge of subject:	Ms Yu
HOLA in charge of subject:	Ms Bennet

COURSE OUTLINE

This is an academic course that requires fluency in algebraic skills. This course builds on previous years work and establishes the basis for tertiary study in Mathematics and Statistics. This course of advanced Mathematics extends and develops the algebraic, trigonometric and statistical work begun in Year 11. An introduction to differential and integral calculus is also part of the course.

STANDARDS

Standards for this course will be selected from those listed below and are at the discretion of the HOLA
 Level 2 Standards that contribute to Literacy and Numeracy are indicated by (L) = Literacy; (N) = Numeracy
 Level 2 & 3 Standards that contribute to UE literacy requirements are indicated by (R) = Reading; (W) = Writing

VOCATIONAL PATHWAYS

Vocational Pathway information helps with future career planning. Each Standard has been aligned to a potential Pathway, reflected by a tick in the relevant column of the table. "What is your pathway?" Please refer to page 5 in this book or pages 22 and 23 in the Level 1-3 Information Book for more information regarding Vocational Pathways.

STANDARDS						VOCATIONAL PATHWAYS					
Number	Subject Ref	Title	Int/Ext	Credits	CODES	Construction & Infrastructure	Manufacturing & Technology	Primary Industries	Service Industries	Social & Community Services	Creative Industries
<i>NCEA Internal Achievement Standards/Unit Standards</i>											
AS91257	Mathematics 2.2	Apply graphical methods in solving problems	Internal	4	N	✓	✓	✓	✓		✓
AS91264	Mathematics 2.9	Use statistical methods to make an inference	Internal	4	L/N			✓	✓	✓	✓
AS91259	Mathematics 2.4	Apply trigonometric relationships in solving problems	Internal	3	N	✓	✓				✓
<i>NCEA External Achievement Standards</i>											
AS91261	Mathematics 2.6	Apply algebraic methods in solving problems	External	4	N	✓	✓	✓			✓
AS91262	Mathematics 2.7	Apply calculus methods in solving problems	External	5	N	✓	✓	✓			✓
AS91267	Mathematics 2.12	Apply probability methods in solving problems	External	4	N			✓	✓	✓	✓
<i>Possible Credits Available</i>			24 Credits								
						<i>Total recommended ✓ credits</i>					
						16	16	21	12	8	24
						<i>Total sector related ✓✓ credits</i>					

MEDIA STUDIES (2MED)

COURSE INFORMATION

Qualification and level:	NCEA Level 2
Course Prerequisites:	14 credits in Level One Media Studies or application and acceptance by TIC.
Fieldwork:	Field Day Trip to either a media industry, tertiary institution or film viewing.
Approximate Course Costs:	Anywhere between \$20-50 approximately. (tbc) Students are expected to pay for all trips taken and film screenings at the end of the year. Each trip planned may have different costs.
Course Leads to:	NCEA Level 3 Media Studies
Course Provider/Assessor:	Botany Downs Secondary College
Teacher in charge of subject:	Mr Greenstreet
HOLA in charge of subject:	Ms Pinnell

COURSE OUTLINE

Media Studies provides opportunities for students to develop and explore the impact all forms of media have on our lives. Media Studies is a fast-growing option choice for students who want to further their career opportunities in Media and Communications or to gain more experience in using theory to critically analyse media texts and the world around them.

The course builds on the skills developed from Media Studies in Year 11 and provides an excellent pathway into Level 3 Media Studies and to a range of tertiary study options. The course contains a strong theory component, which will cover a genre study of horror film, representation of women in the media and the study of ethical issues in the media. Students will also be involved in producing a short film in groups and will develop their technical skills in camera, sound and editing.

Media literacy is a very important aspect of our lives that deserves further critical scholarship and investigation. Students will find this course fun and challenging as they further their understanding of the various concepts in the changing media and our society. The rigour of the course will prepare students for further study, either at Level 3 of NCEA, or at a tertiary level.

Students are strongly encouraged to bring their own devices like laptops, cameras and earphones to enable a smoother learning process.

STANDARDS

Standards for this course will be selected from those listed below and are at the discretion of the HOLA
 Level 2 Standards that contribute to Literacy and Numeracy are indicated by (L) = Literacy; (N) = Numeracy
 Level 2 & 3 Standards that contribute to UE literacy requirements are indicated by (R) = Reading; (W) = Writing

VOCATIONAL PATHWAYS

Vocational Pathway information helps with future career planning. Each Standard has been aligned to a potential Pathway, reflected by a tick in the relevant column of the table. "What is your pathway?" Please refer to page 5 in this book or pages 22 and 23 in the Level 1-3 Information Book for more information regarding Vocational Pathways.

STANDARDS						VOCATIONAL PATHWAYS					
Number	Subject Ref	Title	Int/Ext	Credits	CODES	Construction & Infrastructure	Manufacturing & Technology	Primary Industries	Service Industries	Social & Community Services	Creative Industries
<i>NCEA Internal Achievement Standards/Unit Standards</i>											
AS 91249	Media Studies 2.2	Demonstrate understanding of narrative in media texts	Internal	4	L						✓✓
AS 91250	Media Studies 2.3	Demonstrate understanding of representation in the media	Internal	3	L						✓✓
AS 91252	Media Studies 2.5	Produce a design and plan for a developed media product, using a range of conventions	Internal	4	L						✓✓
AS 91253	Media Studies 2.6	Complete a developed media product from a design and plan, using a range of conventions	Internal	6	L				✓	✓	✓✓
AS 91254	Media Studies 2.7	Demonstrate understanding of an ethical issue in the media	Internal	3					✓	✓	✓✓
<i>NCEA External Achievement Standards</i>											
AS 91251	Media Studies 2.4	Demonstrate understanding of an aspect of a media genre	External	4	L						✓
<i>Possible Credits Available</i>			24 Credits								
						<i>Total recommended ✓ credits</i>					
						9 9 4					
						<i>Total sector related ✓✓ credits</i>					
						20					

MICROSOFT OFFICE SPECIALIST (2MOS)

COURSE INFORMATION

Qualification and level:	NCEA Level 1, 2 (multi level)
Course Prerequisites:	Open entry or recommendation of Whanau Leader or Deputy Principal
Fieldwork:	Nil
Approximate Course Costs:	Nil
Course Leads to:	Vocational pathway in services and/or social and community services
Course Provider/Assessor:	Botany Downs Secondary College
Teacher in charge of subject:	Mr Patchigalla
HOLA in charge of subject:	Mr Achary

COURSE OUTLINE

Microsoft Office Specialist (MOS) is an international certification of proficiency in the Microsoft Office suite of applications, providing valued skills for employment, using the worlds most popular business suite. BDSC is a certification centre as a Microsoft Imagine Academy. The course is expected to be self-paced, so that students will master different application using a variety of learning resources and activities (print, e-books, online videos). Ideally, students will complete project-based learning and assessments from other subject areas to develop these skills. The assessment is by online testing within the applications.

Students can gain MOS in Word, Excel, PowerPoint, Outlook, Access, and OneNote. The Microsoft Office Expert in also possible in Word and Excel. A student may be awarded Microsoft Office Master by achieving 4 MOS certificates. In addition, as shown by the table below, MOS and MOE courses can be credited to NCEA in a process called 'credit inclusion' as replacements for Unit Standards, at the end of an academic year. The key advantages of this course is that it is **multi-level** (Years 12-13), **personalised** (choose which applications and how many) **on-line and completed at a student's own pace**.

Entrance to this course is by application to (or invitation from) Whanau Leaders or Senior Leadership Team.

STANDARDS

Standards for this course will be selected from those listed below and are at the discretion of the HOLA
 Level 2 Standards that contribute to Literacy and Numeracy are indicated by (L) = Literacy; (N) = Numeracy
 Level 2 & 3 Standards that contribute to UE literacy requirements are indicated by (R) = Reading; (W) = Writing

VOCATIONAL PATHWAYS

Vocational Pathway information helps with future career planning. Each Standard has been aligned to a potential Pathway, reflected by a tick in the relevant column of the table. "What is your pathway?" Please refer to page 5 in this book or pages 22 and 23 in the Level 1-3 Information Book for more information regarding Vocational Pathways.

STANDARDS						VOCATIONAL PATHWAYS					
Number	Subject Ref	Title	Int/Ext	Credits	CODES	Infrastructure	Construction & Technology	Manufacturing & Primary Industries	Service Industries	Social & Community Services	Creative Industries
<i>Microsoft Course</i>											
Business Information Processing	US107 & 111 (Level 2)	Microsoft Office Word	Internal	4						✓	
Generic Computing	US2784 (Level 2)	Microsoft Office Excel	Internal	4		✓	✓	✓	✓	✓	✓
Generic Computing	US5940 (Level 3)	Microsoft Office Powerpoint	Internal	4		✓	✓				✓✓
Business Information Processing	US2787 (Level 3)	Microsoft Office Access	Internal	5							
Generic Computing	US112 (Level 3)	Microsoft Office Word Expert	Internal	5							
Generic Computing	US2785 (Level 3)	Microsoft Office Excel Expert	Internal	5							
<i>Possible Credits Available</i>			22 Credits								
						8	8	4	4	8	4
						<i>Total recommended ✓ credits</i>					
						8	8	4	4	8	4
						<i>Total sector related ✓✓ credits</i>					

MULTI MATERIALS TECHNOLOGY (2TEM)

COURSE INFORMATION

Qualification and level:	NCEA Level 2
Course Prerequisites:	At least 3 out of 4 of the Achievement Standards passed at level 1 or HOLA agreement
Fieldwork:	None.
Approximate Course Costs:	\$80 Take home component
Course Leads to:	NCEA Level 3 Materials Technology
Course Provider/Assessor:	Botany Downs Secondary College
Teacher in charge of subject:	Mr Jowers-Wilding
HOLA in charge of subject:	Mr Achary

COURSE OUTLINE

Level 2 Multi Materials Technology is based on the Technology Curriculum and is assessed against four Technology Achievement standards. It provides the opportunity for students to gain 20 or 22 credits at Level 2. There is no examination; however three of the Achievement Standards will be assessed internally and the other one will be assessed through external marking. Students will use a technological approach to develop innovative and creative problem solving skills. Practical skills in a wide range of materials are encouraged along with the learning of techniques and processes. All achievement standards will be attached to a unit of work on 'Lifestyle'.

Please note students can choose only one from of the following Technology options: 2TEM, 2TET, 2TEF.
It is important to note that this course is a prerequisite if students are intending to take Multi-materials Technology in Year 13 next year.

STANDARDS

Standards for this course will be selected from those listed below and are at the discretion of the HOLA
 Level 2 Standards that contribute to Literacy and Numeracy are indicated by (L) = Literacy; (N) = Numeracy
 Level 2 & 3 Standards that contribute to UE literacy requirements are indicated by (R) = Reading; (W) = Writing

VOCATIONAL PATHWAYS

Vocational Pathway information helps with future career planning. Each Standard has been aligned to a potential Pathway, reflected by a tick in the relevant column of the table. "What is your pathway?" Please refer to page 5 in this book or pages 22 and 23 in the Level 1-3 Information Book for more information regarding Vocational Pathways.

STANDARDS						VOCATIONAL PATHWAYS					
Number	Subject Ref	Title	Int/Ext	Credits	CODES	Construction & Infrastructure	Manufacturing & Technology	Primary Industries	Service Industries	Social & Community Services	Creative Industries
<i>NCEA Internal Achievement Standards/Unit Standards</i>											
AS91356 OR AS91354	Technology 2.3 Technology 2.1	Develop a conceptual design for an outcome Undertake brief development to address an issue	Internal	6 4		✓ ✓	✓ ✓	✓ ✓			✓✓ ✓✓
AS91344	Technology 2.20	Implement advanced procedures using resistant materials to make a specified product with special features.	Internal	6		✓✓	✓✓				✓✓
AS91357	Technology 2.4	Undertake effective development to make and trial a prototype	Internal	6		✓	✓✓	✓			✓✓
<i>NCEA External Achievement Standards</i>											
AS91358	Technology 2.5	Demonstrate understanding of how technological modelling supports risk management.	External	4		✓	✓				
<i>Possible Credits Available</i>			20 or 22 Credits								
						20	14	16			
						6	12				22
						<i>Total recommended ✓ credits</i> <i>Total sector related ✓✓ credits</i>					

MUSIC (2MUS)

COURSE INFORMATION

Qualification and level:	NCEA Level 2
Course Prerequisites:	10 credits in NCEA Level 1 Music or at the discretion of HOLA. The ability to read music and play an instrument is essential for those who intend to do NCEA Level 2 Music.
Fieldwork:	Performance trip \$25
Approximate Course Costs:	Accompanist for solo performances \$50 (approx and optional)
Course Leads to:	NCEA Level 3 Music (Music Studies and Practical Music)
Course Provider/Assessor:	Botany Downs Secondary College
Teacher in charge of subject:	Ms Treneman
HOLA in charge of subject:	Ms Treneman

COURSE OUTLINE

This course will build on the experiences of Level 1 Music and will enable students to further develop their knowledge of music's elements, conventions, processes, techniques and technologies. The course provides students with the opportunity to perform as both a featured soloist and as a member of a group; compose a variety of pieces of music, and study music works, identifying, describing and comparing the musical features and social context of the works. The development of aural skills is intrinsic to all music learning. Students must play an instrument and should be learning either through the Itinerant music scheme or privately. Please be aware that the performance Achievement Standards will be assessed during evening concerts open to the school community.

STANDARDS

Standards for this course will be selected from those listed below and are at the discretion of the HOLA
 Level 2 Standards that contribute to Literacy and Numeracy are indicated by (L) = Literacy; (N) = Numeracy
 Level 2 & 3 Standards that contribute to UE literacy requirements are indicated by (R) = Reading; (W) = Writing

VOCATIONAL PATHWAYS

Vocational Pathway information helps with future career planning. Each Standard has been aligned to a potential Pathway, reflected by a tick in the relevant column of the table. "What is your pathway?" Please refer to page 5 in this book or pages 22 and 23 in the Level 1-3 Information Book for more information regarding Vocational Pathways.

STANDARDS							VOCATIONAL PATHWAYS					
Number	Subject Ref	Title	Int/Ext	Credits	CODES	Construction & Infrastructure	Manufacturing & Technology	Primary Industries	Service Industries	Community Services	Social & Creative Industries	
<i>NCEA Internal Achievement Standards/Unit Standards</i>												
AS91270	Music 2.1	Perform two substantial pieces of music as a featured soloist	Internal	6							✓✓	
AS91274	Music 2.2	Perform a substantial piece of music as featured soloist on a second instrument	Internal	3							✓✓	
AS91272	Music 2.3	Demonstrate ensemble skills by performing a substantial piece of music as a member of a group	Internal	4							✓✓	
AS91271	Music 2.4	Compose two substantial pieces of music	Internal	6							✓✓	
AS91273	Music 2.8	Devise an instrumentation for an ensemble	Internal	4							✓✓	
AS91278	Music 2.9	Investigate an aspect of New Zealand music	Internal	4	L						✓✓	
<i>NCEA External Achievement Standards</i>												
AS91275	Music 2.5	Demonstrate aural skill through written representation	External	4							✓✓	
AS91276	Music 2.6	Demonstrate knowledge of conventions in a range of music scores	External	4	L						✓✓	
AS91277	Music 2.7	Demonstrate understanding of two substantial contrasting music works	External	6	L						✓✓	
<i>Possible Credits Available</i>			18-21 Credits									
						<i>Total recommended ✓ credits</i>						
						<i>Total sector related ✓✓ credits</i>						
						41						

OUTDOOR EDUCATION (2OED)

COURSE INFORMATION

Qualification and level:	NCEA Level 2
Course Prerequisites:	12 AS credits from 1OED and a high level of participation and effort in 1OED. Approval from HOD
Fieldwork:	3 day Sea Kayaking trip around Ponui Island, 3 Day Tramping in the Waitakere Ranges, 2 day Rock Climbing camp, 2 Day Mountain Biking trip in Rotorua, 3 day Scuba diving camp at Goat Island
Approximate Course Costs:	\$850
Course Leads to:	3OED
Course Provider/Assessor:	Botany Downs Secondary College
Teacher in charge of subject:	Mr Williams
HOLA in charge of subject:	Mr Saville

COURSE OUTLINE

Level 2 Outdoor Education students will learn a wide variety of outdoor and leadership skills while further developing an appreciation for the environment. The year begins with a three day Sea Kayaking trip around Ponui Island where students will camp and cook and on the private beaches and learn to snorkel and fish to gather kaimoana. In the next unit we study Tramping and Navigation in the bush. Students will learn how to Navigate using compasses, topographical maps, and feature identification to find their way along tracks and through streams in the Waitakere ranges on a three day trip. Our first practical unit is Mountain Biking, where students can earn US credits during a two day camp in Woodhill Forest staying at Parakai Hot Springs. In Term Three work on leadership through rock climbing, where the year 12 students will teach juniors different rock climbing and ABL skills before going on a two day practically assessed Rock Climbing camp in Central Waikato. The year is concluded with a two night Scuba Diving camp at Goat Island where students will learn basic diving skills and about how to look after our marine environment.

STANDARDS

Standards for this course will be selected from those listed below and are at the discretion of the HOLA
 Level 2 Standards that contribute to Literacy and Numeracy are indicated by (L) = Literacy; (N) = Numeracy
 Level 2 & 3 Standards that contribute to UE literacy requirements are indicated by (R) = Reading; (W) = Writing

VOCATIONAL PATHWAYS

Vocational Pathway information helps with future career planning. Each Standard has been aligned to a potential Pathway, reflected by a tick in the relevant column of the table. "What is your pathway?" Please refer to page 5 in this book or pages 22 and 23 in the Level 1-3 Information Book for more information regarding Vocational Pathways.

STANDARDS						VOCATIONAL PATHWAYS						
Number	Subject Ref	Title	Int/Ext	Credits	CODES	Infrastructure	Construction & Technology	Manufacturing & Industries	Primary Industries	Service Industries	Social & Community Services	Creative Industries
<i>NCEA Internal Achievement Standards/Unit Standards</i>												
AS91330	Physical Ed 2.4	Perform a physical activity in an applied setting	Internal	4						✓		✓
AS91333	Physical Ed 2.7	Analyse the application of risk management strategies to a challenging outdoor activity	Internal	3	L			✓	✓	✓	✓	✓
AS91332	Physical Ed 2.6	Evaluate leadership strategies that contribute to the effective functioning of a group	Internal	4	L				✓		✓	✓
AS91336	Physical Ed 2.10	Analyse group processes in physical activity	Internal	3	L			✓	✓		✓	✓
AS91299	Home Economics 2.1	Analyse issues related to the provision of food for people with specific food needs	Internal	5	L				✓		✓	
US431	Outdoor Recreation	Navigate in good visibility on land	Internal	3					✓	✓		
US457	Outdoor Recreation	Mountain Bike on intermediate to experienced terrain	Internal	2					✓	✓		
<i>Possible Credits Available</i>			24 Credits									
								6	16	11	14	
									8	4		
						<i>Total recommended ✓ credits</i> <i>Total sector related ✓✓ credits</i>						

OUTDOOR EDUCATION - ALTERNATIVE (20DA)

COURSE INFORMATION

Qualification and level:	NCEA Level 2
Course Prerequisites:	1OED, 1PED, Approval from HOD
Fieldwork:	3 day surfing camp in Raglan, 4 day canoe trip down Whanganui River, 2 days rock climbing, 3 day sailing trip, 3 day tramping trip in the Kaimai Ranges.
Approximate Course Costs:	\$800
Course Leads to:	3SPL
Course Provider/Assessor:	Botany Downs Secondary College, Bigfoot Adventures
Teacher in charge of subject:	Mr D Williams
HOLA in charge of subject:	Mr J Saville

COURSE OUTLINE

Level 2 Outdoor Education —Alternative is a vocational pathway course where students are predominantly assessed practically through a wide variety of outdoor pursuits across the North Island. Students begin the year by investigating risk management while on a three day surfing camp in Raglan. The next practical unit they study is rock climbing, where the assessment will be entirely practically based at a local Rock Climbing area. Students will then learn about New Zealand’s native bush during a three day tramp in the Kaimai Ranges staying in two classic North Islands bush huts. Students will also learn about how to interoperate weather forecasts and put this to practice on a three day Sailing trip aboard the famous yacht Steinlager 2. The final expedition is ticking off one of the countries infamous Great Walks, embarking on a four day journey down the Whanganui River in Canadian Canoes staying at two huts as well having as a true cultural experience staying at a Marae on the third night.

STANDARDS

Standards for this course will be selected from those listed below and are at the discretion of the HOLA
 Level 2 Standards that contribute to Literacy and Numeracy are indicated by (L) = Literacy; (N) = Numeracy
 Level 2 & 3 Standards that contribute to UE literacy requirements are indicated by (R) = Reading; (W) = Writing

VOCATIONAL PATHWAYS

Vocational Pathway information helps with future career planning. Each Standard has been aligned to a potential Pathway, reflected by a tick in the relevant column of the table. “What is your pathway?” Please refer to page 5 in this book or pages 22 and 23 in the Level 1-3 Information Book for more information regarding Vocational Pathways.

STANDARDS					VOCATIONAL PATHWAYS						
Number	Subject Ref	Title	Int/Ext	Credits	CODES	Construction & Infrastructure	Manufacturing & Technology	Primary Industries	Service Industries	Social & Community Services	Creative Industries
<i>NCEA Internal Achievement Standards/Unit Standards</i>											
AS91330	Physical Ed 2.4	Perform a physical activity in an applied setting	Internal	4					✓		✓
AS91333	Physical Ed 2.7	Analyse the application of risk management strategies to a challenging outdoor activity	Internal	3	L			✓	✓✓	✓	✓
US426	Outdoor Recreation	Experience camping	Internal	3					✓✓		
US431	Outdoor Recreation	Navigate in good visibility on land	Internal	3					✓✓		
US20819	Outdoor Recreation	Demonstrate Canoeing skills on Grade 1 water	Internal	3					✓✓		
US21930	Outdoor Recreation	Make safety preparations when sailing a keel boat	Internal	2							
<i>Possible Credits Available</i>			18 Credits								
<i>Total recommended ✓ credits</i>								3	4	3	7
<i>Total sector related ✓✓ credits</i>									12		

PHYSICAL EDUCATION (2PED)

COURSE INFORMATION

Qualification and level:	NCEA Level 2
Course Prerequisites:	12 credits in NCEA Level 1 Physical Education (should include AS 1.2) and 5 credits in 1HPE or HOLA approval AND shown a high level of effort and commitment in 1PED.
Fieldwork:	Offsite Practical work to be confirmed.
Approximate Course Costs:	\$800
Course Leads to:	Level 3 PE & Scholarship
Course Provider/Assessor:	Botany Downs Secondary College
Teacher in charge of subject:	Mr Saville
HOLA in charge of subject:	Mr Saville

COURSE OUTLINE

Physical Education promotes learning in, through and about movement. Level 2 Physical Education requires a more in depth study of how the body works and how to train it. In this course we bring together knowledge in sport, sociology and science through the disciplines of human physiology, psychology, biomechanics, social responsibility and researching critical issues in sport. This course has the potential to further students understanding to lead to exciting career opportunities in fields such (and not limited to) education, health professions, coaching and fitness industries and sport and exercise science. Theory is applied to the practical situations, sports and activities. The contexts in the practical will vary but will include a selection of activities such as individual and team sports and fitness training.

STANDARDS

Standards for this course will be selected from those listed below and are at the discretion of the HOLA
 Level 2 Standards that contribute to Literacy and Numeracy are indicated by (L) = Literacy; (N) = Numeracy
 Level 2 & 3 Standards that contribute to UE literacy requirements are indicated by (R) = Reading; (W) = Writing

VOCATIONAL PATHWAYS

Vocational Pathway information helps with future career planning. Each Standard has been aligned to a potential Pathway, reflected by a tick in the relevant column of the table. "What is your pathway?" Please refer to page 5 in this book or pages 22 and 23 in the Level 1-3 Information Book for more information regarding Vocational Pathways.

STANDARDS						VOCATIONAL PATHWAYS					
Number	Subject Ref	Title	Int/Ext	Credits	CODES	Construction & Infrastructure	Manufacturing & Technology	Primary Industries	Service Industries	Social & Community Services	Creative Industries
<i>NCEA Internal Achievement Standards/Unit Standards</i>											
AS91328	Physical Ed 2.2	Demonstrate understanding of how and why biophysical principles relate to the learning of physical skills	Internal	5	L1 Lit				✓✓	✓	✓
AS91329	Physical Ed 2.3	Demonstrate understanding of the application of biophysical principles to training for physical activity	Internal	4	L1 Lit				✓✓		✓
AS91330	Physical Ed 2.4	Perform a physical activity in an applied system	Internal	4					✓		✓
AS91331	Physical Ed 2.5	Explain the significance for self, others and society of a sporting event, a physical activity, or a festival	Internal	4	L1 Lit				✓	✓	✓
AS91334	Physical Ed 2.8	Consistently demonstrate social responsibility through applying a social responsibility model in physical activity	Internal	3					✓	✓	✓
<i>Possible Credits Available</i>			20 Credits								
						<i>Total recommended ✓ credits</i>					
						<i>Total sector related ✓✓ credits</i>					
						11 12 20					
						9					

PHYSICS (2PHY)

COURSE INFORMATION

Qualification and level:	NCEA Level 2
Course Prerequisites:	10 credits in NCEA Level 1 Achievement Standards in Science/Physics - including at least 8 credits from 90940, 90935/90937 and 10 credits in NCEA Level 1 Mathematics Achievement Standards. Students who do not meet the above prerequisites but who still wish to study Physics at NCEA Level 2 will require the HOD's endorsement.
Fieldwork:	Nil
Approximate Course Costs:	\$20.00 Education Perfect online resources
Course Leads to:	Level 3/Year 13 Physics
Course Provider/Assessor:	Botany Downs Secondary College
Teacher in charge of subject:	Mr Raj
HOLA in charge of subject:	Mr Kumar

COURSE OUTLINE

Physics is the study of forces, energy and matter. Physics is an important subject for many sports, material and engineering studies. We use a range of methods, with an emphasis on experimental evidence and investigations, to provide a solid foundation for studying physics in the future. Emphasis is placed on understanding the key concepts of physics within suitable contexts including technological applications. Students are required to carry out calculations using formulae and describe and explain physics concepts. Level 2 Physics is an essential prerequisite for Level 3 Physics. This course includes the following topics: 1. Experimental physics 2. Waves and light 3. Kinematics and vectors 4. Force and motion 5. Work, energy and power 6. Current electricity 7. Electromagnetism. 8. Atomic and Nuclear Physics

STANDARDS

Standards for this course will be selected from those listed below and are at the discretion of the HOLA
 Level 2 Standards that contribute to Literacy and Numeracy are indicated by (L) = Literacy; (N) = Numeracy
 Level 2 & 3 Standards that contribute to UE literacy requirements are indicated by (R) = Reading; (W) = Writing

VOCATIONAL PATHWAYS

Vocational Pathway information helps with future career planning. Each Standard has been aligned to a potential Pathway, reflected by a tick in the relevant column of the table. "What is your pathway?" Please refer to page 5 in this book or pages 22 and 23 in the Level 1-3 Information Book for more information regarding Vocational Pathways.

STANDARDS						VOCATIONAL PATHWAYS					
Number	Subject Ref	Title	Int/Ext	Credits	CODES	Construction & Infrastructure	Manufacturing & Technology	Primary Industries	Service Industries	Social & Community Services	Creative Industries
<i>NCEA Internal Achievement Standards/Unit Standards</i>											
AS91168	Physics 2.1	Carry out a practical physics investigation that leads to a non-linear mathematical relationship	Internal	4	L/N	✓	✓	✓		✓	✓
AS91172	Physics 2.5	Demonstrate understanding of atomics and nuclear Physics	Internal	3	L/N	✓	✓			✓	✓
<i>NCEA External Achievement Standards</i>											
AS91170	Physics 2.3	Demonstrate understanding of waves	External	4	L/N	✓	✓	✓		✓	✓
AS91171	Physics 2.4	Demonstrate understanding of mechanics	External	6	L/N	✓	✓	✓		✓	✓
AS91173	Physics 2.6	Demonstrate understanding of electricity and Electromagnetism	External	6	L/N	✓	✓	✓		✓	✓
<i>Possible Credits Available</i>			23 Credits								
						23	23	20	23	23	23
						<i>Total recommended ✓ credits</i>					
						<i>Total sector related ✓✓ credits</i>					

SPANISH (2SPH)

COURSE INFORMATION

Qualification and level:	NCEA Level 2
Course Prerequisites:	10 credits in NCEA Level 1 Spanish including standard 90911(Reading)
Fieldwork:	Possible competitions: debating and speech competitions
Approximate Course Costs:	Course Costs \$30 including subscription to Education Perfect website
Course Leads to:	NCEA Level 3 Spanish
Course Provider/Assessor:	Botany Downs Secondary College
Teacher in charge of subject:	Miss Grall
HOLA in charge of subject:	Ms Lodge

COURSE OUTLINE

"One language sets you in a corridor for life. Two languages open every door along the way." Frank Smith

This course builds students' confidence to express and exchange ideas to establish real communication in Spanish.

Students will gain the skills to express opinions, to present facts and arguments on a range of topics such as health, relationships, trends and cinema.

The assessments for Level 2 Spanish consist of a writing portfolio, a spoken presentation, a reading exam and a listening exam.

STANDARDS

Standards for this course will be selected from those listed below and are at the discretion of the HOLA
 Level 2 Standards that contribute to Literacy and Numeracy are indicated by (L) = Literacy; (N) = Numeracy
 Level 2 & 3 Standards that contribute to UE literacy requirements are indicated by (R) = Reading; (W) = Writing

VOCATIONAL PATHWAYS

Vocational Pathway information helps with future career planning. Each Standard has been aligned to a potential Pathway, reflected by a tick in the relevant column of the table. "What is your pathway?" Please refer to page 5 in this book or pages 22 and 23 in the Level 1-3 Information Book for more information regarding Vocational Pathways.

STANDARDS						VOCATIONAL PATHWAYS					
Number	Subject Ref	Title	Int/Ext	Credits	CODES	Construction & Infrastructure	Manufacturing & Technology	Primary Industries	Service Industries	Social & Community Services	Creative Industries
<i>NCEA Internal Achievement Standards/Unit Standards</i>											
AS91150	Spanish 2.2	Give a spoken presentation in Spanish that communicates information, ideas and opinions	Internal	4							
AS91152	Spanish 2.5	Write a variety of text types in Spanish to convey information, ideas, and opinions in genuine contexts	Internal	5					✓		✓
<i>NCEA External Achievement Standards</i>											
AS91148	Spanish 2.1	Demonstrate understanding of a variety of spoken Spanish texts on familiar matters	External	5					✓		✓
AS91151	Spanish 2.4	Demonstrate understanding of a variety of written and/or visual Spanish text(s) on familiar matters	External	5					✓		
<i>Possible Credits Available</i>			19 Credits								
						<i>Total recommended ✓ credits</i>					
						15					
						<i>Total sector related ✓✓ credits</i>					
						10					

SPORTS LEADERSHIP (2SPL)

COURSE INFORMATION

Qualification and level:	NCEA Level 2
Course Prerequisites:	A proven enthusiasm in HPE would be beneficial and is suitable to students who are prepared to take on the responsibility of leadership. TIC and HOLA approval needed.
Fieldwork:	Nil
Approximate Course Costs:	Approximately \$40
Course Leads to:	Level 3 Sports Leadership
Course Provider/Assessor:	Botany Downs Secondary College / First Aid Provider
Teacher in charge of subject:	Mr Adams
HOLA in charge of subject:	Mr Saville

COURSE OUTLINE

Level 2 Sports Leadership promotes learning in, through and about movement. The students will complete a selection of the standards below that range from different leadership opportunities, communication and feedback skills, first aid, leadership strategies and implementation of an event. This course has the potential to further students understanding to lead to exciting career opportunities in fields such (and not limited to) health professions, coaching and fitness industries. Theory is applied to the practical situations, sports and activities. The contexts in the practical will vary but will include a selection of activities, individual and team sports and fitness training.

STANDARDS

Standards for this course will be selected from those listed below and are at the discretion of the HOLA
 Level 2 Standards that contribute to Literacy and Numeracy are indicated by (L) = Literacy: (N) = Numeracy
 Level 2 & 3 Standards that contribute to UE literacy requirements are indicated by (R) = Reading: (W) = Writing

VOCATIONAL PATHWAYS

Vocational Pathway information helps with future career planning. Each Standard has been aligned to a potential Pathway, reflected by a tick in the relevant column of the table. "What is your pathway?" Please refer to page 5 in this book or pages 22 and 23 in the Level 1-3 Information Book for more information regarding Vocational Pathways.

STANDARDS						VOCATIONAL PATHWAYS					
Number	Subject Ref	Title	Int/Ext	Credits	CODES	Construction & Infrastructure	Manufacturing & Technology	Primary Industries	Service Industries	Social & Community Services	Creative Industries
<i>NCEA Internal Achievement Standards/Unit Standards</i>											
AS91330	Physical Ed 2.4	Perform a physical activity in an applied setting.	Internal	4					✓		✓
AS 91332	Physical Ed 2.6	Evaluate leadership strategies that contribute to the effective functioning of a group.	Internal	4					✓	✓✓	
AS 91335	Physical Ed 2.9	Examine the implication and outcome of a physical activity event or opportunity.	Internal	3					✓	✓	
US467	-	Adventure based learning	Internal	3					✓✓	✓✓	
US22770	-	Demonstrate knowledge of sport coaching, the coaching environment, and sports applicate needs	Internal	4					✓✓	✓✓	
US21649	-	Apply knowledge of basic anatomy to the performance of sport skills	Internal	3					✓✓	✓✓	
US20137	-	Mountain Bike on easy to medium terrain	Internal	1					✓		
<i>Possible Credits Available</i>			22 credits								
						<i>Total recommended ✓ credits</i>					
						<i>Total sector related ✓✓ credits</i>					
						12 3 4					
						10 14					

TEXTILES TECHNOLOGY (2TET)

COURSE INFORMATION

Qualification and level:	NCEA Level 2
Course Prerequisites:	Students who have achieved a minimum of 10 credits in Textiles Technology NCEA Level 1 or have prior approval from the teacher.
Fieldwork:	Visit from professionals in the area of pattern development. Trip to fabric retailers to research fabric and trim options for the major project. Opportunity to experience WOW and the costume department of the Royal New Zealand Ballet in Wellington. Approximate cost: \$350 if undertaken
Approximate Course Costs:	\$40 to cover class materials and sewing kit. Students are to supply their own fabric and pattern for garment production.
Course Leads to:	NCEA Level 3 / Textiles Technology
Course Provider/Assessor:	Botany Downs Secondary College
Teacher in charge of subject:	Ms Lynskey
HOLA in charge of subject:	Mr Achary

COURSE OUTLINE

Level 2 Textiles Technology focuses on further developing the creative and technical skills required to pursue a career in a range of creative industries such as apparel and textile design, as well as costume for film, television and stage productions. Students will have the opportunity to use creative problem solving, as well as build on their machine, pattern drafting, and design skills to earn a combination of achievement standard credits. The major project requires the students to use technological practice to develop a portfolio of work, designing and producing an item for a competition. Please note we are also offering a Level Two Unit Standard in fashion illustration which may be chosen as a substitute for AS91356. The options will be discussed in class. Areas such as; couture design, street wear, wearable art, or set design could be chosen as a theme. The second project is shorter and is to further develop sewing and pattern drafting skills (AS3.26). Students who partake in this course will be preparing themselves for tertiary study in fashion, costume or interior design and a high level of competence in a valuable life skill. Please note, AS91358 is available for those students who may have clash with the DVC AS91337 External.

Please note students can choose only one from of the following Technology options: 2TEM, 2ET, 2TEF.

STANDARDS

Standards for this course will be selected from those listed below and are at the discretion of the HOLA
 Level 2 Standards that contribute to Literacy and Numeracy are indicated by (L) = Literacy; (N) = Numeracy
 Level 2 & 3 Standards that contribute to UE literacy requirements are indicated by (R) = Reading; (W) = Writing

VOCATIONAL PATHWAYS

Vocational Pathway information helps with future career planning. Each Standard has been aligned to a potential Pathway, reflected by a tick in the relevant column of the table. "What is your pathway?" Please refer to page 5 in this book or pages 22 and 23 in the Level 1-3 Information Book for more information regarding Vocational Pathways.

STANDARDS						VOCATIONAL PATHWAYS					
Number	Subject Ref	Title	Int/Ext	Credits	CODES	Construction & Infrastructure	Manufacturing & Technology	Primary Industries	Service Industries	Social & Community Services	Creative Industries
<i>NCEA Internal Achievement Standards/Unit Standards</i>											
AS91356	Generic Technology 2.3	Develop a conceptual design for an outcome	Internal	6		✓	✓	✓			✓✓
US16837	Home and life sciences: Level 2	Prepare for and produce fashion drawings	Internal	3							✓✓
AS91345	Technology 2.21	Implement advanced procedures using textiles materials to make a specified product with special features.	Internal	6		✓✓	✓✓				✓✓
AS91350	Technology 3.26	Make advanced adaptations to a pattern to change the structural and style features of a pattern.	Internal	4		✓✓	✓✓				✓✓
<i>NCEA External Achievement Standards</i>											
AS91337	Design and Visual Communication	Use visual communication techniques to generate design ideas	External	3		✓✓	✓	✓	✓		✓✓
Optional AS91358	Generic Technology	Demonstrate understanding of how technological modelling supports risk management.	External	4	L	✓	✓				
<i>Possible Credits Available</i>			19 Credits								
						10	13	9	3		
						13	10				22

TRAVEL & TOURISM (2TSM)

COURSE INFORMATION

Qualification and level:	NCEA Level 2
Course Prerequisites:	75 credits at Level 1 - including 12 credits in English and 10 credits in Numeracy
Fieldwork:	Nil
Approximate Course Costs:	\$50
Course Leads to:	Level 3 Travel and Tourism
Course Provider/Assessor:	Botany Downs Secondary College
Teacher in charge of subject:	Mrs Brook
HOLA in charge of subject:	Mr Andrew

COURSE OUTLINE

Level 2 Travel and Tourism is a vocational subject. Students achieve Unit Standards which allow them to work towards study at tertiary level. Tourism is one of New Zealand's fastest growing industries, the school recognises this fact and the Level 2 course provides interested students with a foot in the door. Students will cover the basics of Travel and Tourism throughout the course. The focus is on knowledge of the Tourism industry in terms of work roles, business and impacts. It will also provide students with geographical and historical knowledge of New Zealand. Students who do not meet the prerequisites may make an application for this course.

STANDARDS

Standards for this course will be selected from those listed below and are at the discretion of the HOLA
 Level 2 Standards that contribute to Literacy and Numeracy are indicated by (L) = Literacy; (N) = Numeracy
 Level 2 & 3 Standards that contribute to UE literacy requirements are indicated by (R) = Reading; (W) = Writing

VOCATIONAL PATHWAYS

Vocational Pathway information helps with future career planning. Each Standard has been aligned to a potential Pathway, reflected by a tick in the relevant column of the table. "What is your pathway?" Please refer to page 5 in this book or pages 22 and 23 in the Level 1-3 Information Book for more information regarding Vocational Pathways.

STANDARDS						VOCATIONAL PATHWAYS					
Number	Subject Ref	Title	Int/Ext	Credits	CODES	Construction & Infrastructure	Manufacturing & Technology	Primary Industries	Service Industries	Social & Community Services	Creative Industries
<i>NCEA Internal Achievement Standards/Unit Standards</i>											
US24732	-	Tourist Characteristics	Int	3					✓✓		
US24728	-	Work Roles in Tourism	Int	3					✓✓		
US24731	-	Destination New Zealand	Int	4					✓✓		
US24729	-	World Tourist Destinations	Int	4					✓✓		
US24730	-	The Business of Tourism	Int	4					✓✓		
US24727	-	Performing Calculations	Int	3					✓✓		
US24726	-	Impacts: Social and Cultural	Int	3					✓✓		
<i>Possible Credits Available</i>			24 Credits								
<i>Total recommended ✓ credits</i>											
<i>Total sector related ✓✓ credits</i>									24		

VISUAL ART - DESIGN (2DES)

COURSE INFORMATION

Qualification and level:	NCEA Level 2
Course Prerequisites:	16 credits in Year 11 Digital Art, or application and acceptance by HOD/TIC
Fieldwork:	Gallery visit
Approximate Course Costs:	\$45 (including folio printing)
Course Leads to:	Level 3 and Scholarship Design
Course Provider/Assessor:	Botany Downs Secondary College
Teacher in charge of subject:	Ms Cunningham
HOLA in charge of subject:	Ms Clapperton

COURSE OUTLINE

Design is a discipline. If done well, it facilitates this exchange by presenting new ideas, products and services in a way that draws the viewer in and communicates information clearly and concisely, with as little effort on the part of the viewer as possible. Design is the architecture of information. Designers work in almost every vocation in the modern world. Art Design provides an introduction to the necessary basic skills and tools for students considering a career in any design based field. This course will cover a variety of media and software applications in order to give a broad base of basic knowledge. Specifically they will have an introduction to illustration, typography, identity design, image manipulation, advertising and animation in a variety of media. Leading design software such as Illustrator, InDesign and Photoshop CC will help students to collate and present their ideas into a final outcome. This is an exciting course that will help students focus on the best of traditional art and computer-aided design into one discipline.

Students must purchase a copy of Adobe Photoshop CS5 or higher for their home computers. Recommended Adobe CC suite which is purchased offline for a monthly fee from Adobe. Information on purchasing the required programmes can be found at <https://creative.adobe.com/en/plans?plan=edu> at AUS\$14.99/month (current special for students/teachers) for multiple programmes. Adobe normally have special deals at the beginning of the year for students, so it may end up cheaper than this.

Students who did not take Level 1 Digital Art will need to submit a portfolio application to be considered for this course. Applications can be obtained from Miss Clapperton (HOD of Art).

It is important to note that this course is a prerequisite if students are intending to take Design in Year 13 next year. Please note students can only take a maximum of two subjects from Visual Art: Painting (2ART), Photography (2PHO) or Design (2DES) at Level 2, and are warned against taking 2 Art subjects and another 3rd large internal subject.

STANDARDS

Standards for this course will be selected from those listed below and are at the discretion of the HOLA
 Level 2 Standards that contribute to Literacy and Numeracy are indicated by (L) = Literacy; (N) = Numeracy
 Level 2 & 3 Standards that contribute to UE literacy requirements are indicated by (R) = Reading; (W) = Writing

VOCATIONAL PATHWAYS

Vocational Pathway information helps with future career planning. Each Standard has been aligned to a potential Pathway, reflected by a tick in the relevant column of the table. "What is your pathway?" Please refer to page 5 in this book or pages 22 and 23 in the Level 1-3 Information Book for more information regarding Vocational Pathways.

STANDARDS						VOCATIONAL PATHWAYS					
Number	Subject Ref	Title	Int/Ext	Credits	CODES	Construction & Infrastructure	Manufacturing & Technology	Primary Industries	Service Industries	Social & Community Services	Creative Industries
<i>NCEA Internal Achievement Standards/Unit Standards</i>											
AS91310	Design 2.2	Use drawing methods to apply knowledge of conventions appropriate to design	Internal	4							✓✓
AS91315	Design 2.5	Produce a resolved work that demonstrates control of skills appropriate to cultural conventions	Internal	4							✓✓
<i>NCEA External Achievement Standards</i>											
AS91321	Design 2.4	Produce a systematic body of work that shows understanding of art making conventions and ideas within design	External	12							✓✓
<i>Possible Credits Available</i>			20 Credits								
						<i>Total recommended ✓ credits</i>					
						<i>Total sector related ✓✓ credits</i>					
						20					

VISUAL ART - PAINTING (2ART)

COURSE INFORMATION

Qualification and level:	NCEA Level 2
Course Prerequisites:	16 credits in NCEA Level 1 Visual Art
Fieldwork:	Gallery visit
Approximate Course Costs:	\$60
Course Leads to:	NCEA Level 3 Visual Art
Course Provider/Assessor:	Botany Downs Secondary College
Teacher in charge of subject:	Mr Clark
HOLA in charge of subject:	Ms Clapperton

COURSE OUTLINE

A practical painting course that builds on experiences from Level 1 Visual Art. Students cover the basics of drawing and the art-making process in Painting. The course provides students with a range of artistic skills experiences and techniques. The course prepares students for Level 3 Visual Art.

Students who did not take Level 1 Visual Art will need to submit a portfolio application to be considered for this course. Applications can be obtained from Miss Clapperton (HOD of Art).

It is important to note that this course is a prerequisite if students are intending to take Visual Art-Painting in Year 13 next year. Please note students can only take a maximum of two subjects from Visual Art: Painting (2ART), Photography (2PHO) or Design (2DES) at Level 2, and are warned against taking 2 Art subjects and another 3rd large internal subject.

STANDARDS

Standards for this course will be selected from those listed below and are at the discretion of the HOLA
 Level 2 Standards that contribute to Literacy and Numeracy are indicated by (L) = Literacy; (N) = Numeracy
 Level 2 & 3 Standards that contribute to UE literacy requirements are indicated by (R) = Reading; (W) = Writing

VOCATIONAL PATHWAYS

Vocational Pathway information helps with future career planning. Each Standard has been aligned to a potential Pathway, reflected by a tick in the relevant column of the table. "What is your pathway?" Please refer to page 5 in this book or pages 22 and 23 in the Level 1-3 Information Book for more information regarding Vocational Pathways.

STANDARDS							VOCATIONAL PATHWAYS				
Number	Subject Ref	Title	Int/Ext	Credits	CODES	Construction & Infrastructure	Manufacturing & Technology	Primary Industries	Service Industries	Social & Community Services	Creative Industries
<i>NCEA Internal Achievement Standards/Unit Standards</i>											
AS91311	Visual Art 2.2	Use drawing methods to apply knowledge of conventions appropriate to painting	Internal	4		✓	✓				✓✓
AS91316	Visual Art 2.3	Develop ideas in a related series of drawings appropriate to established painting practice	Internal	4		✓	✓				✓✓
<i>NCEA External Achievement Standards</i>											
AS91321	Visual Art 2.4	Produce a systematic body of work that shows understanding of art making conventions and ideas within painting	External	12		✓	✓				✓✓
<i>Possible Credits Available</i>			20 Credits								
			<i>Total recommended ✓ credits</i>								
			<i>Total sector related ✓✓ credits</i>		20						

VISUAL ART - PHOTOGRAPHY (2PHO)

COURSE INFORMATION

Qualification and level:	NCEA Level 2
Course Prerequisites:	16 credits in Year 11 Digital Art, or application and acceptance by HOD/TIC
Fieldwork:	Gallery visit
Approximate Course Costs:	\$50 including final folio board printing, students must have their own camera and at least a 4GB USB
Course Leads to:	NCEA Level 3 Photography
Course Provider/Assessor:	Botany Downs Secondary College
Teacher in charge of subject:	Ms Clapperton
HOLA in charge of subject:	Ms Clapperton

COURSE OUTLINE

Photography is about communicating thoughts and emotions through images. Level 2 Photography requires a depth of analysis and justification of photographic methods. Presentation is also expected to be of a high standard. Using Photoshop, understanding file systems, setting up a studio with lights, planning, taking and creating digitised images and working as a team are some of the practical skills that will be enhanced during this course. The Level 2 Photography course will cover topics such as: Conventions of Photography, Photoshop and Studio Lighting. There is no external examination, students will complete 3 projects throughout the year contributing to the required Standards.

Students are to have their own good quality digital camera (at least 7MP with manual features; Aperture and Shutter Speed), a storage device to transfer files to and from home (4 or 8 GB USB recommended).

Students must purchase a copy of Adobe Photoshop CS5 or higher for their home computers. Recommended Adobe CC suite which is purchased offline for a monthly fee from Adobe. Information on purchasing the required programmes can be found at <https://creative.adobe.com/en/plans?plan=edu> at AUS\$14.99/month (current special for students/teachers) for multiple programmes. Adobe normally have special deals at the beginning of the year for students, so it may end up cheaper than this.

Note: this is an artistic subject. Students must be creative and must be ICT literate and be very confident with using a computer.

Students who did not take Level 1 Digital Art will need to submit a portfolio application to be considered for this course. Applications can be obtained from Miss Clapperton (HOD of Art).

It is important to note that this course is a prerequisite if students are intending to take Photography in Year 13 next year. Please note students can only take a maximum of two subjects from Visual Art: Painting (2ART), Photography (2PHO) or Design (2DES) at Level 2, and are warned against taking 2 Art subjects and another 3rd large internal subject.

STANDARDS

Standards for this course will be selected from those listed below and are at the discretion of the HOLA
 Level 2 Standards that contribute to Literacy and Numeracy are indicated by (L) = Literacy: (N) = Numeracy
 Level 2 & 3 Standards that contribute to UE literacy requirements are indicated by (R) = Reading: (W) = Writing

VOCATIONAL PATHWAYS

Vocational Pathway information helps with future career planning. Each Standard has been aligned to a potential Pathway, reflected by a tick in the relevant column of the table. "What is your pathway?" Please refer to page 5 in this book or pages 22 and 23 in the Level 1-3 Information Book for more information regarding Vocational Pathways.

STANDARDS						VOCATIONAL PATHWAYS							
Number	Subject Ref	Title	Int/Ext	Credits	CODES	Infrastructure & Construction	Technology & Manufacturing	Primary Industries	Service Industries	Social & Community Services	Creative Industries		
<i>NCEA Internal Achievement Standards/Unit Standards</i>													
AS91312	Photography 2.2	Use drawing methods to apply knowledge of conventions appropriate to Photography	internal	4							✓✓		
AS91317	Photography 2.3	Develop ideas in a related series of drawings appropriate to established Photography practice	Internal	4							✓✓		
<i>NCEA External Achievement Standards</i>													
AS91322	Photography 2.4	Produce a systematic body of work that shows understanding of art making conventions and ideas within Photography	External	12							✓✓		
<i>Possible Credits Available</i>			20 Credits										
<i>Total recommended ✓ credits</i>													
<i>Total sector related ✓✓ credits</i>											20		